





**Front cover**  
A rare gathering of so many models.  
The manufacturers had to wait quite a  
few weeks before we could return their  
instruments.  
Photo: Burkhardt/Free.aero Magazine

# CONTENTS

*Translation by Ruth Jessop*

What's the point?	3
The flight recorder	9
GSM live tracking	15
Live tracking by satellite	26
Measuring the wind	39
Air speed probes: true speed	46
Instruments: the new generation	51
Gyro-vario: new sensors and algorithms	52



A compass in flight on a paramotor. Ten years ago, lots of free flying pilots were still flying with them. Today obviously, GPSs have taken over.  
Photo: Sascha Burkhardt

# WHAT'S THE POINT?



Height when flying is an important piece of information, especially when you're after a record as was the case here with this Flytec Element during the summer of 2015 above Mont Blanc. But this isn't necessarily the most important display for everyday flights. Photo: Tim Green  
[www.epictv.com/photo/article/5-things-you-need-to-break-world-record](http://www.epictv.com/photo/article/5-things-you-need-to-break-world-record)

**F**ortunately we fly the simplest aircrafts that exist, and can fly perfectly well without any instruments. Certain purists even do this. At the same time, the instrument market is booming. There has never been as many manufacturers and models specifically for paramotors and paragliders. What are the useful functions and which are gimmicks or gadgets? We'll introduce most of the functions further on in this issue.

#### THE SOUND

Just a word about the bare bones which even the free flying purists like to have. To core a thermal far from the relief the famous 'bipbip' noise is essential. Basically this is because we don't have any sense which allows us to know far from the relief, high up in a thermal, whether or not we are still going up, going round in zeros, or already going down. It is even more useful in weak conditions.



In free flight, to core efficiently, an acoustic vario is the bare minimum. Here's a pioneer in the domain: it came out more than 20 years ago. Even back then, it was just powered by solar energy, well before that was fashionable. It is still on sale for about 140 €. Photo: Sascha Burkhardt



Progression EN/LTF A

# KOYOT 3

**Adventurer-to-be**

Flying is in you. Now it is the time to take off and finally enjoy the magic of surfing the sky. The Koyot 3 is a simple and emotive glider for any new adventurer to discover. It is the ideal partner for leisurely flights.



Far from the relief, humans don't have a sense which really allows us to feel the vertical speed nor to differentiate between a deceleration of the descent and the start of a climb. A member of the Compass Instruments team explained to us why, according to him, our instinct can't replace an instrument: [www.voler.info/cms/contents/Tribune-Luca-Basso.pdf](http://www.voler.info/cms/contents/Tribune-Luca-Basso.pdf)  
Photo : Felix Wölk/Ozone

A barograph showing the last few minutes of a flight. It's a very useful function which doesn't require a GPS. Yet it was only recently that the manufacturers integrated it into their instruments. Photo: Sascha Burkhardt

Apart from a few signs given by the smell of the air and the behaviour of the wing when going into a thermal, it isn't really possible to tell the difference between acceleration upwards after going through neutral air and descending less rapidly after descending more rapidly.

Both give a similar increase in G forces. An acoustic vario seems therefore to be the bare minimum as far as instruments go. The differences between the products on the market is fairly large, not so much as far as response speed is concerned, but more for adjusting the acoustics, as we'll see later on.

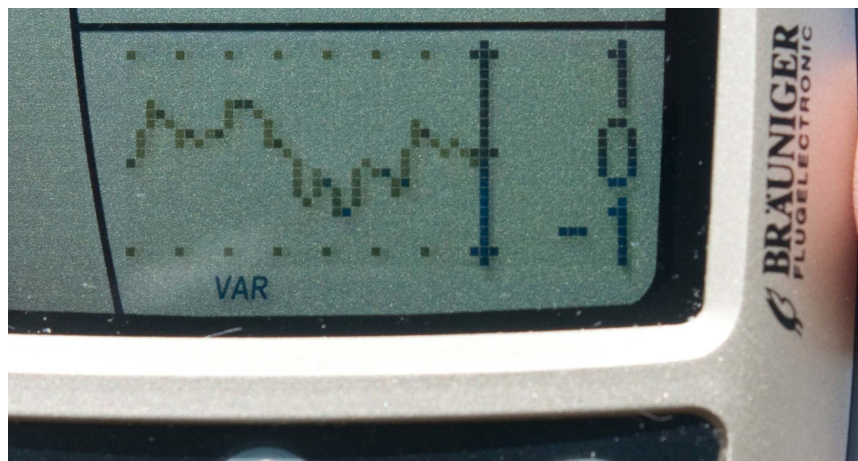

# Genie Lite 2

Size	XS	S	M	L
Weight (kg)	3.9	4.1	4.4	4.6
Pilot height (cm)	<165	160-175	170-185	>180

The Genie Lite 2 is for sport and XC pilots who want a light cocoon harness with all the essential features and no compromises in comfort.



GIN



SKYMAN

Live your adventure!

Ultra-light equipment for adventurers,  
XC and tandem pilots.

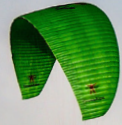

The freedom of lightness!



**GPS**

The other really important function, even more important than the display of absolute or relative altitudes is, for lots of pilots, the speed over the ground. This value, which can only be obtained by a GPS chip, gives an idea of the wind speed at the actual flight level. This allows the position of lee side zones to be deduced as well as the probable strength of the turbulence.

It also allows the probable wind speed on the ground to be deduced without guaranteeing it, of course, if there is substantial wind shear.

Previously, the GPS chip was the prerogative of top of the range instruments. Now, given the fairly low price of this type

of component, this valuable tool for giving the position is becoming commonplace in instruments at the low end of the range, including minivarios.

**TOOL FOR CENTRING THERMALS**

The Top Navigator by Aircotec was the visionary precursor to a fully fledged GPS instrument, as early as from 1997 onwards, well before the others. On its screen, thanks to its GPS, it drew a point where ever lift was encountered. Thus it built up a 'geographical map of thermals', which was revolutionary. On the other hand, today, most manufacturers prefer a simple indication of the direction of the last thermal encountered; this is almost as efficient.

**OTHER ADVANCES**

As our modern paragliders are carrying us further and further, it has become important to watch out for airspace. Over the last three years, almost all instruments with a GPS have integrated a function



Almost a museum piece: a Top Navigator from 1998. It weighed 465 g without the battery and 600 g with it! But it was revolutionary; thanks to the GPS, it drew a map of the thermals around the pilot (1), and it was the first instrument to calculate the speed and the direction of the wind (top).

Moreover, it also showed the temperature gradient of the air crossed (5) and drew a curve showing the variation in temperature (4). The instrument can still be ordered new (890 €).

[http://www.aircotec.com/cms/front\\_content.php?idcat=39](http://www.aircotec.com/cms/front_content.php?idcat=39)

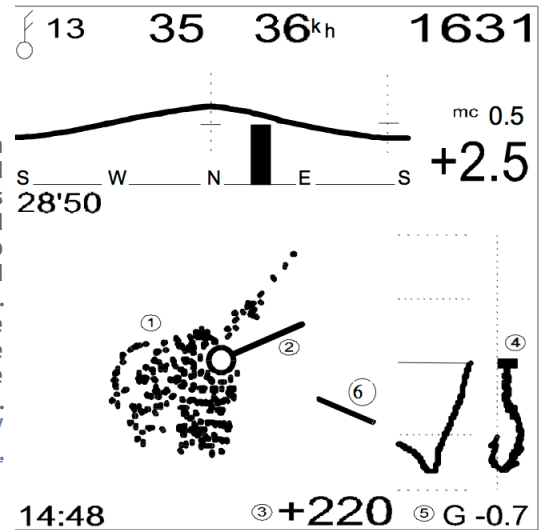





**PARATROC**  
La boutique parapente

Online store - Paragliding equipment

First shop for used paragliders

Over 3000 products in stock  
Express shipping in Europe  
Interest free 3 months credit

Doussard - Lac d'Annecy  
Importer France - Ava Sport & Plusmax



[www.paratroc.com](http://www.paratroc.com)

### THE FLIGHT RECORDER

A function which is becoming increasingly important on instruments with a GPS: recording a tracklog. With a predefined interval, for example every five minutes, the instrument or the smartphone registers the position in 3D.

After the flight, this tracklog can be sent (via a computer for example) to the server of a cross country competition such as XContest ([www.xcontest.org](http://www.xcontest.org)). There you'll see your flight appear in the ranking for that day and year. To be valid on these international websites, the IGC tracklog must have an 'anti cheating' checksum known as a G-Record. This is now generated directly in most instruments. The connection from modern instruments to the computer is a lot easier now. Previously the connections had to be made via a serial port and specialised software was necessary.

Now the instruments plug in like USB keys and they look like hard discs in the file managers. This allows a tracklog to be easily chosen so that it can be uploaded to the XContest server or similar. It's worth noting that flight recordings can also contain other parameters for each point on

the tracklog, such as air temperature or air speed if an anemometric probe has been plugged in. The visualisation and analysis of these values, as a general rule, requires a special programme provided by the instrument manufacturer.

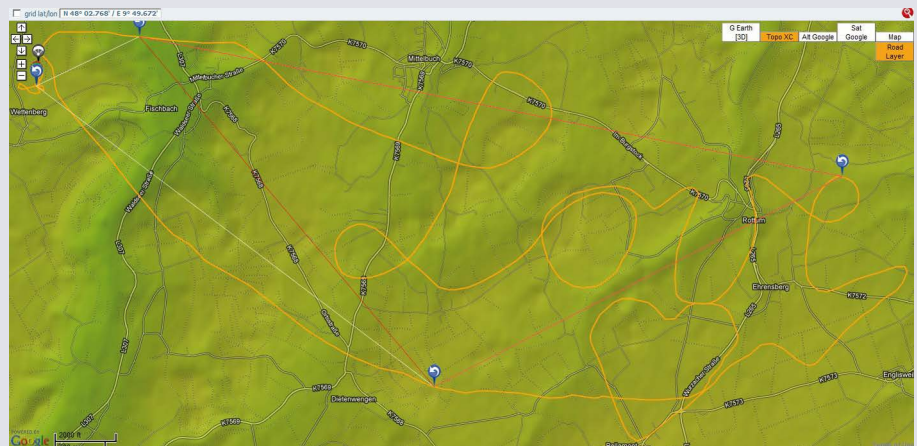

TAF  
 NEAREST  
 AIRPORT  
 LFMN 060200Z 0603/0709  
 34007KT CAVOK PROB30  
 TEMPO 0612/0618 FEW040TCU  
 TEMPO 0614/0622 20010KT  
 NEAREST PLOUPIOU: 270 10619 (KMH)  
 FLIGHT PARAMS:  
 G=+1.1 ALT GPS=1450M AGL=420M  
 TRK=269 TAS=31 KMH GS=25 KMH  
 T=12° DEW 9° QNH=1009  
 WIND 265° 6 KMH  
 NEXT WPT: BAR\_LANDING  
 330° 10KM PROB BOMB=75%  
 PROB CRASH=2%  
 NEXT BOMB\_OUT: 40°  
 0.6 KM

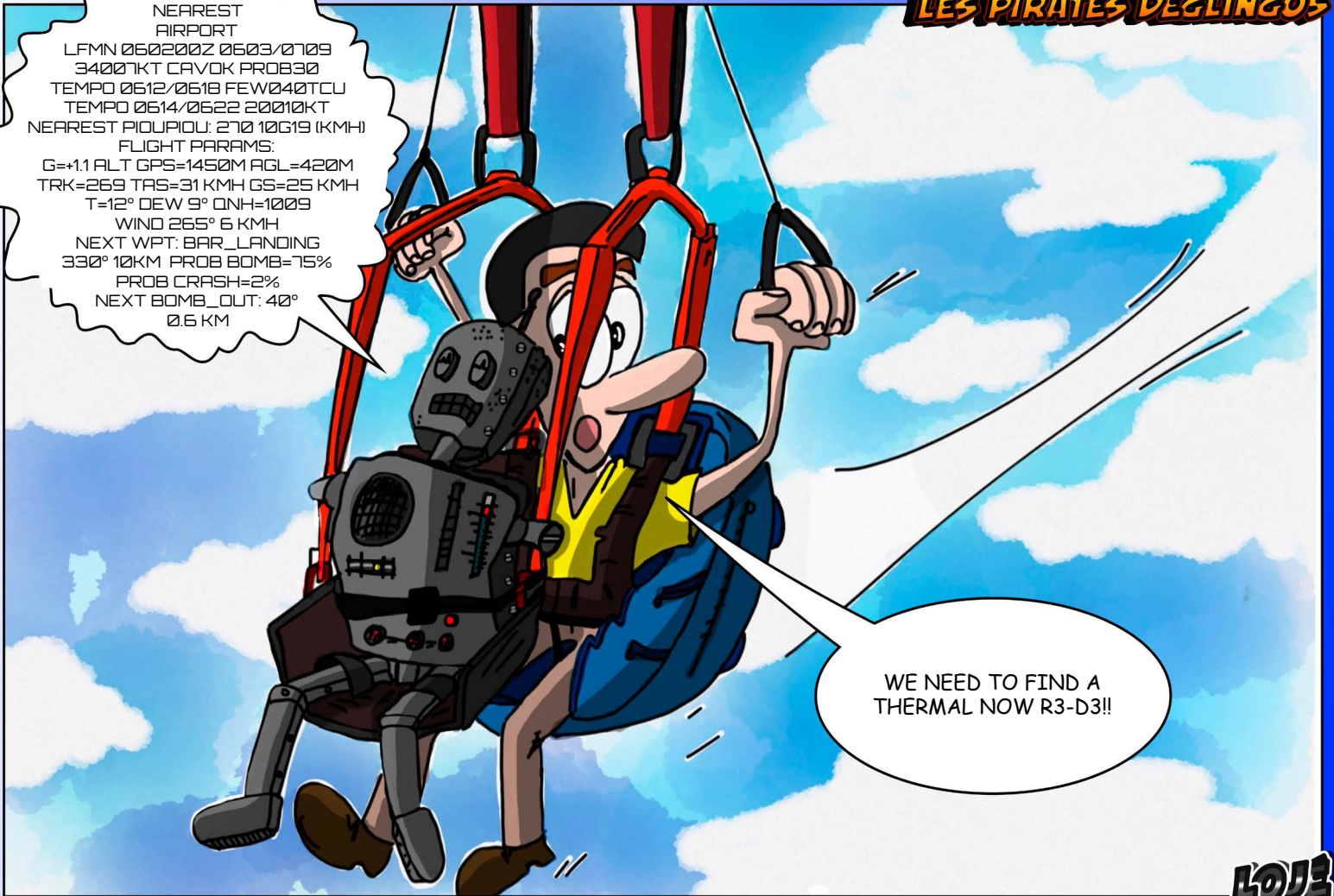

LORE

Almost all these parameters have a real sense and a certain use when flying. It shows the necessity to 'tidy up' by defining the essentials. On all the top of the range instruments, the pilot can choose the values which will be displayed and their size on the screen.

## The whole range of Syride instruments upgraded to V3



syride  
[www.syride.com](http://www.syride.com)

to at least warn of nearby airspace, or otherwise, to draw it on a map on the screen. More details are given in the description of the instruments.

It's interesting to note moreover that modern smartphones haven't taken the place of these instruments. An Android smartphone or an iPhone contains a GPS, a touch screen which is often very readable and can serve, thanks to its high processing power, as an advanced map reader.

Yet the manufacturers of instruments are bringing out more and more models which resemble smart phones but which are specifically for free and motorised flying. There are even a growing number of models with an integrated slot for a SIM card, that approach a smartphone, rather



## **Buzz Z5** by OZONE

### SharkNose Performance, Legendary Comfort

The Buzz Z5 is the highest performance Buzz that we have made, and the most solid and comfortable Intermediate class wing that we have ever flown. The Buzz legacy of comfort and ease of use has received a huge performance upgrade with the patented Ozone SharkNose profile, double 3D shaping, optimized line layout, overall line length reduction, and more cells, all of which mean reduced drag and increased glide and speed. Best of all, these performance upgrades come at no cost in passive safety, because the aspect ratio remains the same. This balance of performance and safety is the most important consideration for any pilot, and the Z5 offers what we think is the ideal amount of both for long XC flights in real conditions.

The Buzz Z5, like its predecessor, is suitable for a wide range of pilots. It is an ideal choice for those who fly 30-50 hours per year, or for experienced pilots seeking a wing with high levels of passive safety and comfort in the Intermediate Class.



With today's wings, it's getting easier and easier to go off on long XCs. A real means of navigation has thus become the preoccupation of a growing number of pilots.  
Photo: Niviuk

Not yet invented: the real revolution would be compact thermal vision glasses which would show the columns of warm air and inversion layers in real time. Yet the basic technology exists, Schlieren photography. It's a method of imaging which allows you to visualise the different refraction indices in a liquid subjected to compression and turbulence. But the result is far from a pretty diagram like the one on the right.

Diagram: Burkhard Martens, author of educational books.  
[www.thermikwolke.de](http://www.thermikwolke.de)

Below: a Schlieren image of a model of a 1.2 Mach plane in a wind tunnel.

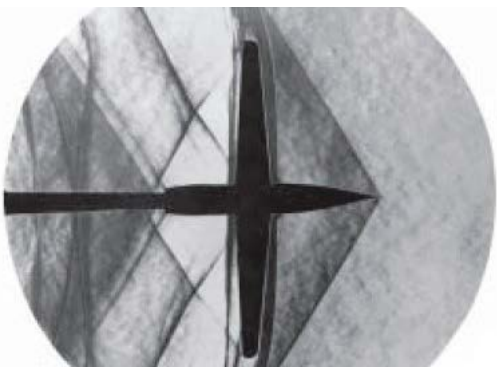
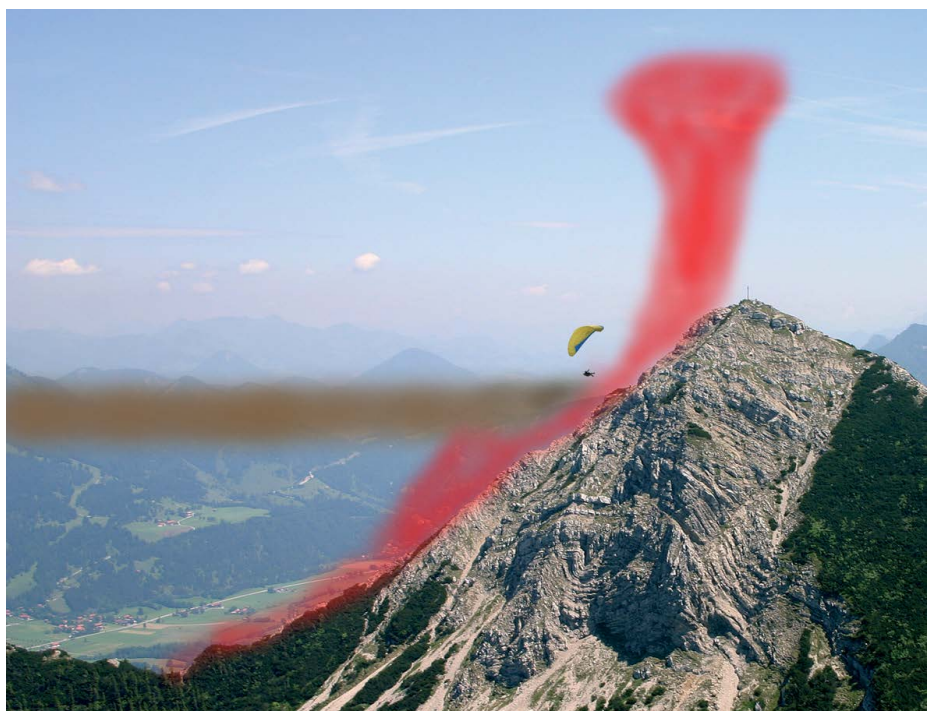



Location on a map: an advantage offered by both top of the range instruments and by smartphones.

than wait for smartphones to replace them permanently.

Therefore there is still significant development going on in the sector for specialised instruments. One of the principal reasons for their success is the limited battery life of a smartphone in GPS mode. Dedicated instruments generally do a lot better and don't need to carry an extra battery.

Often the smartphone serves nonetheless as a safety element. There are applications that can regularly transmit the position of the pilot onto a server on the internet. More and more pilots are becoming aware that regularly transmitting their position can be one of the best forms of life insurance if you have an accident.

That's why we are starting off our article with this type of technology before introducing the instruments in detail. 🛩️

Displaying airspace is an enormous advantage. But the development goes much further, as was already tested on the first application produced for the ASI Flynet (right). We can now know the position of other pilots in real time.

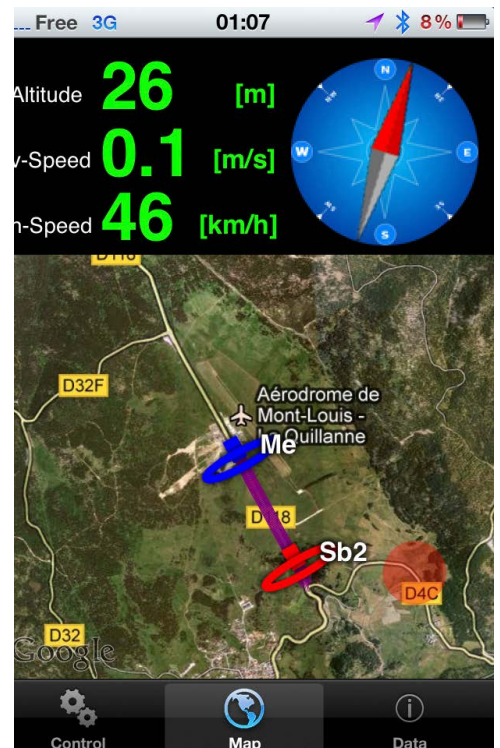
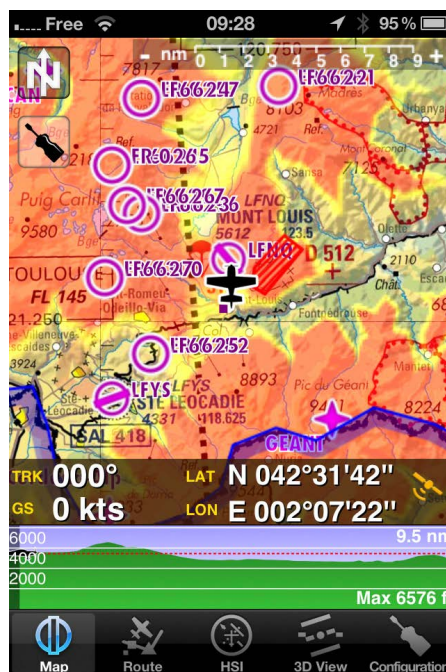



Progression EN/LTF B

# HOOK 4

**The pleasure of choosing**

A progressive and intuitive glider. Easy going flights and more exciting trips? Embrace the accessible performance it delivers, and enjoy the pleasure of choosing your next destination.

**NIVIUK**

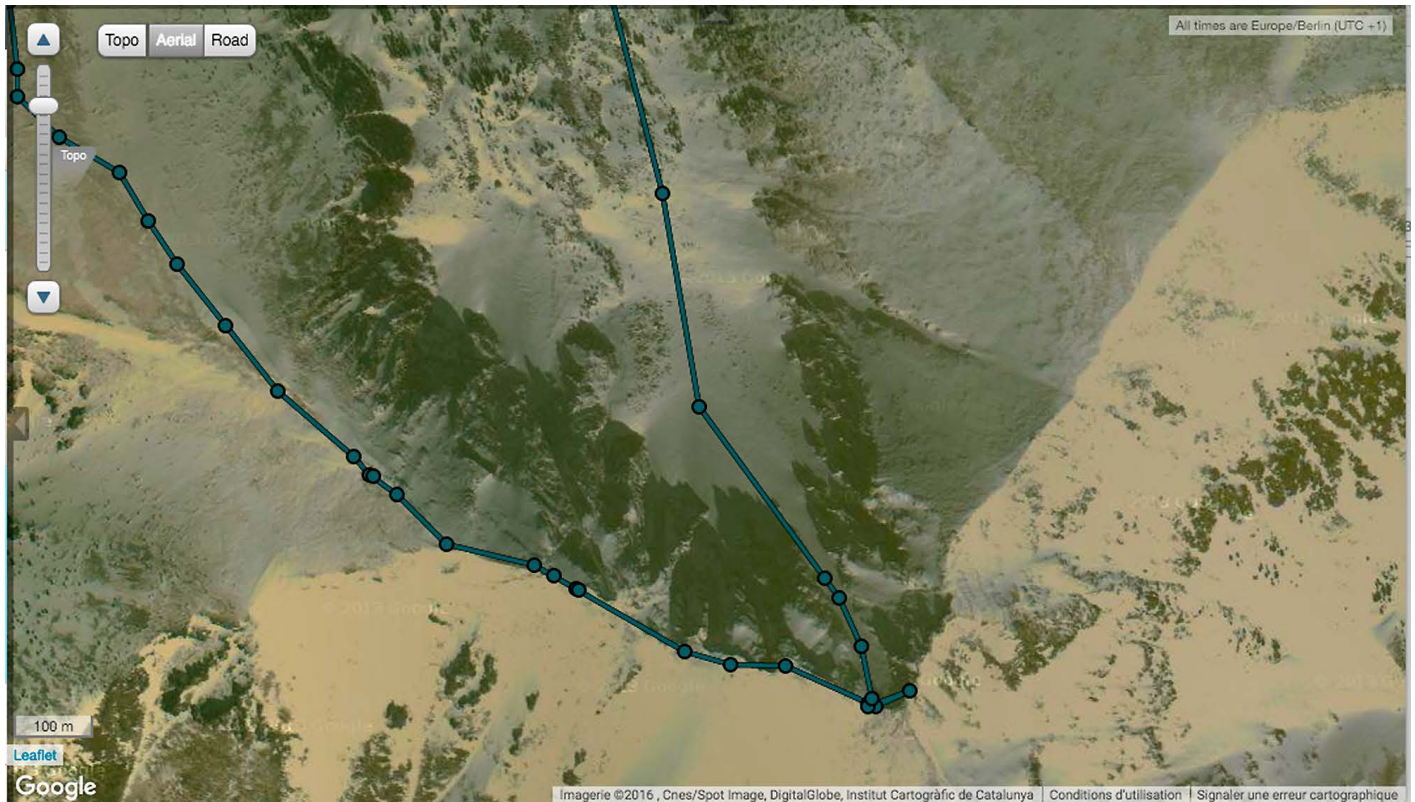

# LIVE TRACKING

## FUN AND SAFE

*If pilots are becoming more and more interested in tracking, it is, amongst other things, thanks to the fun aspect discovered during races such as the X-Alps, but also because it can save lives. Here are the most common ways of being 'tracked'.*

**FLYMASTER**  
Leading the gaggle



VARIO SD

GPS SD

GPS SD+

NAV SD

LIVE SD

Powered by Flymaster



Long or small, the flight will appear live on the internet site. It is also possible to look at the track later on in the site's archives.

# LIVETRACK 24

## THE PIONEER OF TRACKING

**L**ivetrack 24 is one of the oldest tracking services. Its inventor Manolis Andreadakis started it as long ago as 2006! The system is open to all pilots (or even pedestrians/cyclists/walkers etc). All you need to do is open a free account and own a smartphone or one of the many compatible applications, to see your position appear live on the Livetrack 24 internet server. Obviously you need to have a GSM network or satellite coverage. Livetrack 24 offers a link from the following servers: SPOT, YBTracking, DSX and will also soon do the same for Delorme; see further on in this article. Livetrack 24 has about 25 000 accounts and in summer there can be more than 300 people being tracked at the same time.

The service is also used by competitions such as the World Cup, national championships and hike and fly events like X-Pyr or Bornes to Fly. Now, certain organisations directly use the positions collected live to validate tasks and it is no longer necessary to download the contents of their GPSs after the pilots land.



To be tracked by Livetrack 24, lots of leisure pilots simply use their smartphone with a compatible application, primarily the native high performance Livetrack 24 application for iOS or Android, but also navigation applications like Skylogger, ThermGeek and others which integrate a link to Livetrack 24. (To see a list: <http://www.Livetrack24.com/apps/index>).

Some instruments also use Livetrack 24, recent Compass instruments for example. The Flymaster Live can also transmit positions to Livetrack 24, but this passes through the intermediary of the Flymaster server.

If you declare your flights on the XContest server, you can ask Livetrack 24 to transmit your tracklog, after the end of your flight, directly onto XContest. There can be a problem: if some positions haven't been transmitted live, due to a lack of GSM connection for example, the 'holes' can be too big to allow the flight to be validated. In this case, the flight has to be resent by means of a normal download.

In the beginning, Livetrack 24 was first and foremost a safety system, enabling friends and relatives to know at all times where to find a given pilot. Now, the fun side has also become important; it's a bit like a flying version of Facebook.

Using a smartphone is a cheap way of being tracked. You just need to remember an external battery for your smartphone if your flights are going to be longer than a few hours. The basic tracking is free on Livetrack 24; extra options like tracking between friends requires a subscription but the price is reasonable (between 0.83 € and 2 € a month). ☺

<http://www.Livetrack24.com/docs/packages>

The screenshot shows the Livetrack24 website interface. At the top, there are navigation links for Login, Sign Up, Contact, and English. Below the header, there are tabs for Explore LiveTracks (21), Live Events, Services (NEW), and E-Shop. The main content area is titled "Programs \ List of tracking Programs / Devices".

A blue information box states: "The programs that are listed here unless otherwise noted, have been developed by 3rd parties. The icon next to the program name, means that this is a product of LiveTrack24. Some of the developers are giving them for free while others have a cost. In any case you are getting a software product directly from the developer and not from LiveTrack24".

There are two tables of tracking programs:

Device Name	Price	HTTP/TCP/UDP	GPS	Battery	Website
LiveTracker24	169 € [ Order ]	TCP/UDP	5Kb / Hr	>10 Hrs	Home

Program	Price	HTTP/TCP/UDP	GPS	Battery	Website
LiveTrack24+	FREE [ Install ]	HTTP Sockets	30Kb / Hr	<4 Hrs	Home

On the right side, there is a "Buy a Tracking Device" section with images of a tracking device and a smartphone, and a "GPRS calculator" section with an image of a calculator.

Above: The Livetrack 24 site explains all you need to know very clearly and in English. Right: For two years Livetrack 24 has offered a group tracking function: in the air you can see on your Livetrack 24 application where the other pilots in your group are.

The screenshot shows the Livetrack 24 mobile application interface. At the top, there are buttons for Home, Track, and Refresh. Below the header, there are tabs for GPS and Radar. The main content area shows a list of tracked pilots with their names, distances, and altitudes.

The list of tracked pilots is as follows:

Name	Distance	Altitude
Dioan	91.9 km   12 hours, 34 mins, 08 secs ago	186 m
JohnPapa	92.9 km   5 hours, 1 min, 43 secs ago	37 m
Polivios	92.9 km   2 hours, 20 mins, 17 secs ago	23 m

At the bottom, there are buttons for NET, GPS, LIVE, and Premium.



# LIVETRACK 24 LOGGER



**L**ivetrack 24 offers their own tracking device. One advantage is that it's their battery which runs down and not that of your smartphone. It weighs about 70g, and has a battery life of five hours. It is quite easy to operate; you put a SIM card in, charge it, set up the account for the tracker and the latter connects itself. The transfer of data uses about 30 kB per hour, which is very little and remains a good deal across almost all the mobile tariffs, including the prepaid formulas. Conversely, be careful about roaming when you are abroad.

As this device was specially designed for tracking, the manufacturer used a GPS chip with high performance even in difficult conditions. The disadvantages are its battery life being limited to five hours and its price of 180 €.

It's fairly expensive. Especially if you compare it with the price of fully fledged instruments containing a link to the Livetrack 24 server; see further on in this article. 

<http://www.Livetrack 24.com/store/index#trackers>

# SKYTRAXX



Ohne Kompromisse  
*without compromise*



[www.skytraxx.eu](http://www.skytraxx.eu) [info@skytraxx.eu](mailto:info@skytraxx.eu)

© 2007 SKYTRAXX



# LIVE TRACKING BY SYRIDE

ONE OF THE PIONEERS OF ON-LINE FLIGHTS

**S**yride was one of the first manufacturers to offer an online server for all the owners of one of their instruments. After flying, on downloading the track log onto a computer, it is automatically transferred to the server. It was therefore logical that Syride would also be interested in live tracking, but the instruments don't have a GSM/GPRS modem. Syride therefore offer an Android application which takes over and transmits the live position of the pilots.

<https://www.syride.com/en/live>

**F**lymaster is one of the pioneers of live tracking. The instrument manufacturer was one of the first to offer an instrument specifically for tracking, the F1 Live. It was also one of the first to integrate a slot for a SIM card in an instrument, the Flymaster Live. Moreover, for a long time now, Flymaster instruments have been used to track the competitors in the X-Alps. You can even see the heart beat of each competitor thanks to the Flymaster heart rate monitor belt. They offer their own tracking service (<https://lt.flymaster.net/bs.php>). It is open to every owner of a Flymaster Live, Flymaster GPS SD+ or F1 Live equipped with some type of SIM card. It is also possible to transmit the positions onto Livetrack 24 through the Flymaster server.

**THE FLYMASTER SIM**

A great idea from Flymaster was to offer, from March 2016 onwards, its own SIM card. In collaboration with Vodafone, Flymaster offer universal access to their database: this SIM allows an instrument to be connected to the network of several operators in many countries. The vario can thus automatically choose between Orange, Bouygues and SFR in France, depending on the reception. And when you go over the border into Spain, it switches to Movistar, Orange Espagne or Vodafone.

But above all, the card only costs 2.99 € per month, which includes communication in all of these countries. The initial purchase of the card costs 8 €, p&p included. A great idea and not very difficult, allowing you to be tracked without worrying about the telephone tariff. 🇫🇷

# FLYMASTER LIVE-TRACKING TRACKING CHEAPLY...EVERYWHERE

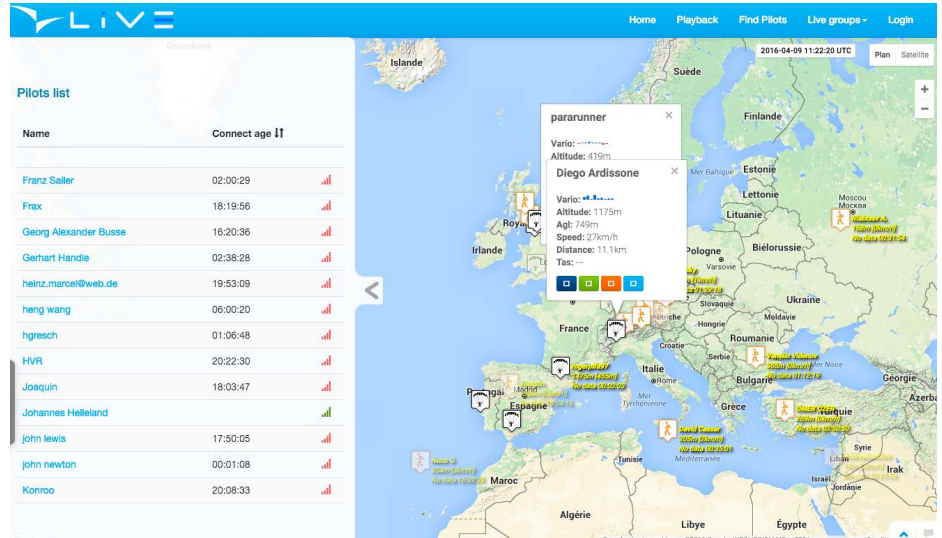

The end of the tariff problems on foreign telephone networks: The Flymaster SIM card is valid in many countries. On the other hand, it only works in a Flymaster instrument. New: their entry level GPS SD + also has a slot for a SIM.

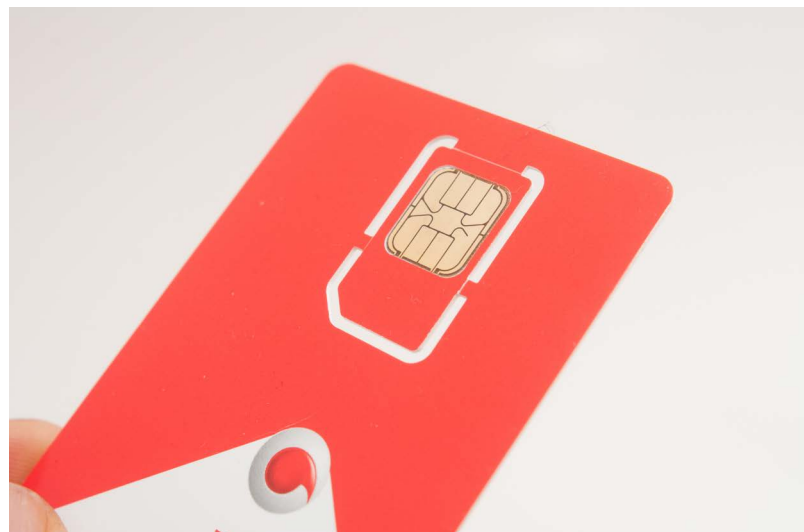

# COMPASS TRACKING

Compass Compass have really taken on board the growing importance of tracking. All the recent Compass instruments, including the entry level Easy Pilot, are equipped with a SIM card slot. As with all instruments of this type, it is necessary to initially remove the SIM card's PIN code, for example using the 'security' menus on a normal mobile phone.

Next you need to find out the APN (access point name) field in the Easy Pilot menu, and depending on the operator, enter its pseudonym and Livetrack 24 password. At the moment, all the tracking at Compass is done via an external service provider, whose reliability is well known. Soon, it will also be possible to send, via Livetrack 24, the whole flight to the XContest server.

Even more impressive, it will soon be possible to see, on the instrument's screen, the position of other pilots who are part of the same group. Shortly, it will also be possible to connect onto the server of the service provider, AirTribune.

Compass recommend and market the SIM card, Onesimcard. In contrast to the Flymaster card, it isn't exclusive to Compass. It costs 30 €, then about 1 € per month, but it isn't an unlimited tariff like the Flymaster one. 🙄



Accueil Suivi temps réel Manuel utilisateur Contact Versions Stickers

Map

Plan

76 pilotes sur la carte

Identification	Etat	Durée du vol	Dernière m-à-j
sandro garcia	On the ground	00:00:28	10/04/2016 13:11:30
13WV	On the ground	00:05:45	10/04/2016 11:02:24
my PPG	On the ground	00:25:01	10/04/2016 10:41:16
Mon paramoteur	On the ground	01:02:50	10/04/2016 10:22:35
il mio Paramotore	On the ground	01:37:24	10/04/2016 10:05:00
my PPG	On the ground	00:26:01	10/04/2016 00:48:14
Mein Position	On the ground	00:02:26	09/04/2016 18:49:43
my PPG	On the ground	03:47:14	09/04/2016 17:39:43
C.Remi	On the ground	00:08:05	09/04/2016 17:39:39
moster ec25 mescal4	On the ground	00:18:24	09/04/2016 14:49:05
Polini Thor 250	On the ground	00:42:09	09/04/2016 10:02:16
Gaby PPG	On the ground	00:48:54	09/04/2016 07:23:05
my PPG	On the ground	00:01:28	08/04/2016 20:34:32
Mon paramoteur	Demo	-	08/04/2016 19:48:42
Hadron 22 Norbi	On the ground	00:22:26	08/04/2016 19:46:40

Afficher les vols sur une période de :

- 48 heures
- Une semaine
- Un mois
- Tous les vols

Rafraichir la carte  
Montrer tous les pilotes

# PPGPS TRACKING

**P**PGPS PPGPS is an Android and iOS navigation application. Initially it was aimed at paramotor pilots, but more and more free flying pilots use it, even though they don't need functions like 'fuel left in the tank'. The application calculates the direction and the speed of the wind and offers help for getting back to base by displaying the estimated time it will take and the direction.

It displays maps from Google Maps and allows you to include other maps, including air space ones (but they still don't generate warnings). You can also use it with an Android Wear watch (see further on in this article).

But PPGPS also offers its own live tracking server with a particularly active community.

[www.ppgps.info](http://www.ppgps.info)

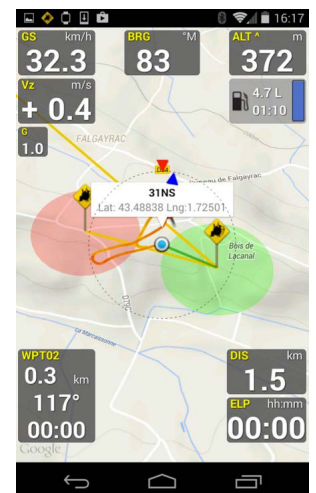
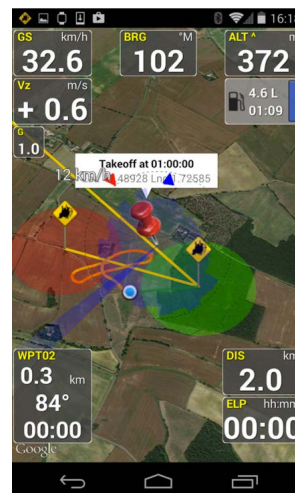
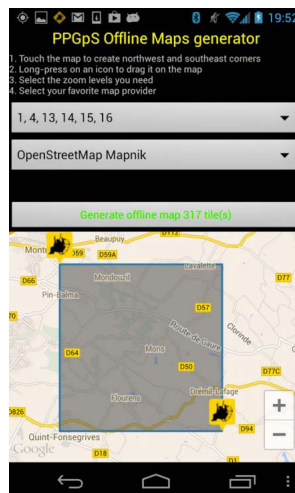

# SMARTPHONE-TRACKING



Photo: Jérôme Maupoint/GIN

*The various navigation applications for iOS and Android make it easy to track any pilot who has activated the tracking mode before flying. But what are the chances of finding him if he has forgotten to activate this function?*

There are two methods of mutual localisation more or less integrated into Android and iOS (Apple's operating system). The pilot can easily allow himself to be 'tracked' by his family or friends, even without having activated a tracking application. All he needs to do is to activate the functions and to clearly give his authorisation.

To be able to find a pilot with an iPhone, you have to first of all invite him to become a friend; he then has to give authorisation to share his position. Both parties have to have an Apple iCloud account (which is free and in any case necessary if you have an iPhone). The person looking for the pilot can do it with the 'Find My Friends' application on an iPhone or an iPad, or otherwise, new since autumn 2015, in any web explorer by opening the page: [www.icloud.com](http://www.icloud.com). This means of finding the other person's actual position works very well, it turned out to be very precise during all our tests.

In the Android world, the two people (pilot and friend) must have a Google Plus account and the pilot who is being looked for must install the Google Plus application on his telephone and explicitly allow his position to be shared with the other person. The easiest way is to create a 'find friends' group and all join it. Then you can see the position of the other person on the Google Plus application, or otherwise, in a web explorer once you've connected to [plus.google.com](http://plus.google.com). It's slightly hidden, you have to click on the person and then once again on their name on their Google Plus page, and then scroll down. That works pretty well too.

In both systems, the person being tracked can very easily disable the tracking, either temporarily or permanently.

An easier and more efficient way of getting the up to date position of the person being looked for is to have access to their iCloud/Google Plus account. This lets you work with the instrument's management system (Android) or 'Find my iPhone' (iOS). But this implies total trust by the person being tracked in the person given the right to look for him. ☹



<https://itunes.apple.com/fr/app/find-my-friends/id466122094?mt=8>

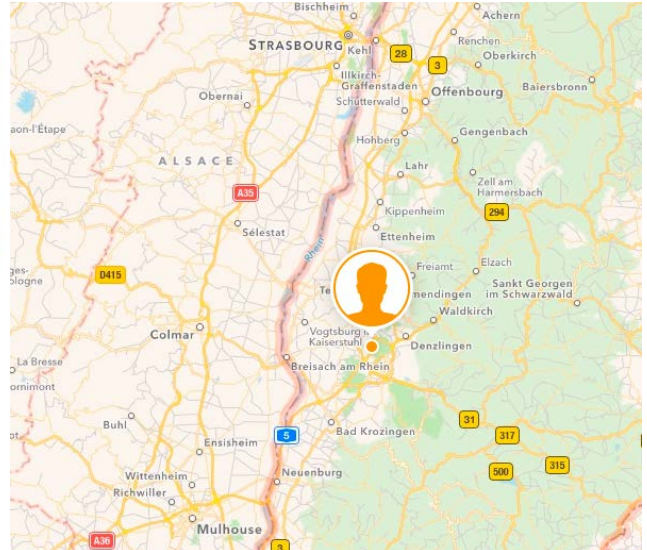

<https://play.google.com/store/apps/details?id=com.google.android.apps.plus>

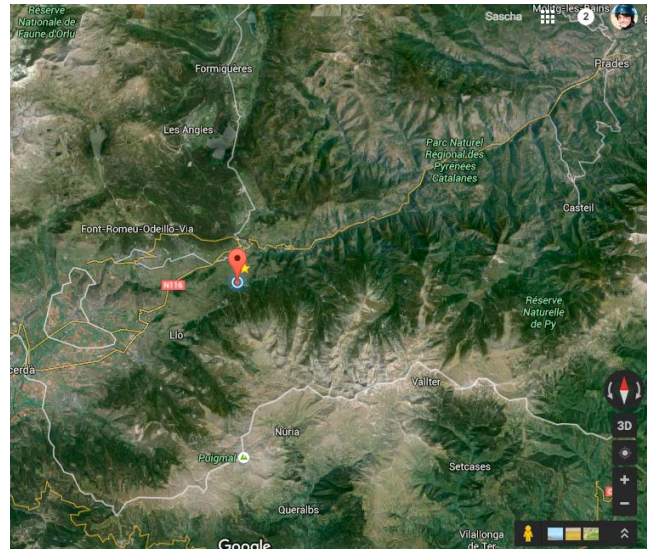

Apple Find my iPhone  
<https://itunes.apple.com/fr/app/localiser-mon-iphone/id376101648?mt=8>



GOOGLE instrument management  
<https://play.google.com/store/apps/details?id=com.google.android.apps.adm>





Come in pilot, where are you? After taking off, you can go far, in all senses of the term.  
Photos and montage: Albasark <http://albasark.com/wordpress/>  
Pilot: Neil Hodgkinson /Location: Bir





# SATELLITE TRACKING

*Whether for a little flight in the Vercors or for a big cross country in the Himalayas, for pilots flying on their own, satellite tracking systems remain unbeatable.*

*They are financially very accessible, and new services make them even easier to use.*



Photo: Nivivuk



Photos: Sascha Burkhardt

Two main systems are normally used: either the Delorme system (on the left) or the SPOT system (on the right). Delorme communicates via Iridium and SPOT via Globalstar. The biggest difference in how they work is that Delorme allows two way communication, including by text message, whereas SPOT only works in the direction pilot to civilisation.

Since we published our tests on the first SPOT satellite trackers in 2008, they have become much more common amongst paraglider pilots. Everyone quickly recognised the importance of a rapid means of finding a missing lone paraglider pilot. And not just in desolate sites on the other side of the world, but also during our Alpine and Pyrenean flights. One can even go as far as to say 'especially' during these 'local' flights. During the majority of our flights we often fly above big forests or inaccessible

ravines. Even as recently as Easter Saturday 2016 a 28 year old American speedflyer disappeared whilst flying in the Jungfrau region of Switzerland. The search was in vain, even though a team from a company which makes drones helped by dividing the sector into a grid and searched using a whole squadron of quadricopters equipped with cameras. ([www.facebook.com/HarrisonFastRescue](http://www.facebook.com/HarrisonFastRescue)).

For obvious security reasons, we therefore strongly advise using a satellite tracking system; it's the only way to find somebody

in an area which isn't covered by a GSM network. The bare minimum, a SPOT tracker, only costs 170 € and its annual subscription is 140 €, therefore about 12 € a month. Our favourite is the Delorme tracker system which costs a bit more (upwards of 310 € for the inReach SE and a monthly cost of 15-25 €), but it is a real two way satellite communication system.

On the following pages, there is a little reminder about these systems as well as what's new... 📡



**AIR CROSS**



Customer service at it's best!

**4-Years insurance\***

[WWW.AIRCROSS.EU](http://WWW.AIRCROSS.EU)

Included when purchasing a glider from AirCross

\* Terms and conditions on our website

Share the ultimate feeling!



# SPOT GEN3



**T**he SPOT tracker has slimmed down since its first version: it weighs no more than about 114 g and works with four AAA batteries. It can also work with a USB supply. This also allows the instrument to be configured in certain ways, such as changing the tracking frequency. This was fixed (10 minutes) on the first SPOTS; now, it can be changed to 5, 10, 30 or 60 minutes or even 2.5 in Extreme Tracking mode, but this is a service you have to pay a supplement for (an extra 100 € per year). Besides tracking, the SPOT tracker also has an 'OK' button which sends a message that everything is OK (by email or SMS) to recipients defined in advance. The 'Help' button triggers a predefined message of the type 'I need help, but it isn't an emergency,' whilst the SOS button triggers an emergency call to the GEOS rescue centres. A new button 'Individual Message' can trigger another

predefined non urgent message.

The system works well and has already saved many lives, but there is a big drawback: it only works in one direction, the pilot can't receive messages telling him, for example, that the emergency services are on their way. Neither can he write a text message, the communication remains limited to the points on the track log and to messages predetermined in advance.

Battery life information given by the manufacturer:

- 10 days in tracking mode with 1 point every 10 minutes
- 6 days in tracking mode with 1 point every 5 minutes

Price of the tracker 170 €,  
Yearly subscription 140 € (12 € per month)

[http://www.balise-spot.fr/la\\_balise.html](http://www.balise-spot.fr/la_balise.html)

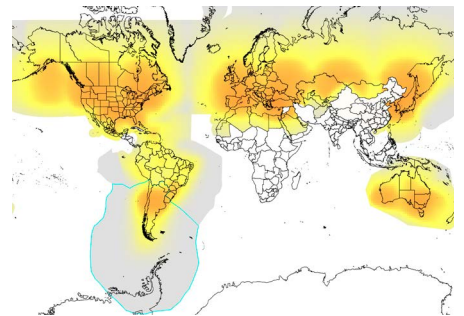

The Globalstar telephone system only covers part of the globe...

...but in 'data' mode and in one direction, i.e. from the user to the Internet or a rescue team, the worldwide coverage is a lot better. This is the basis of the SPOT system.

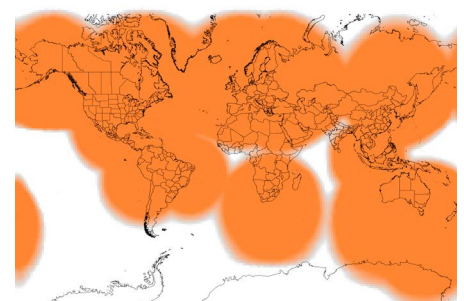

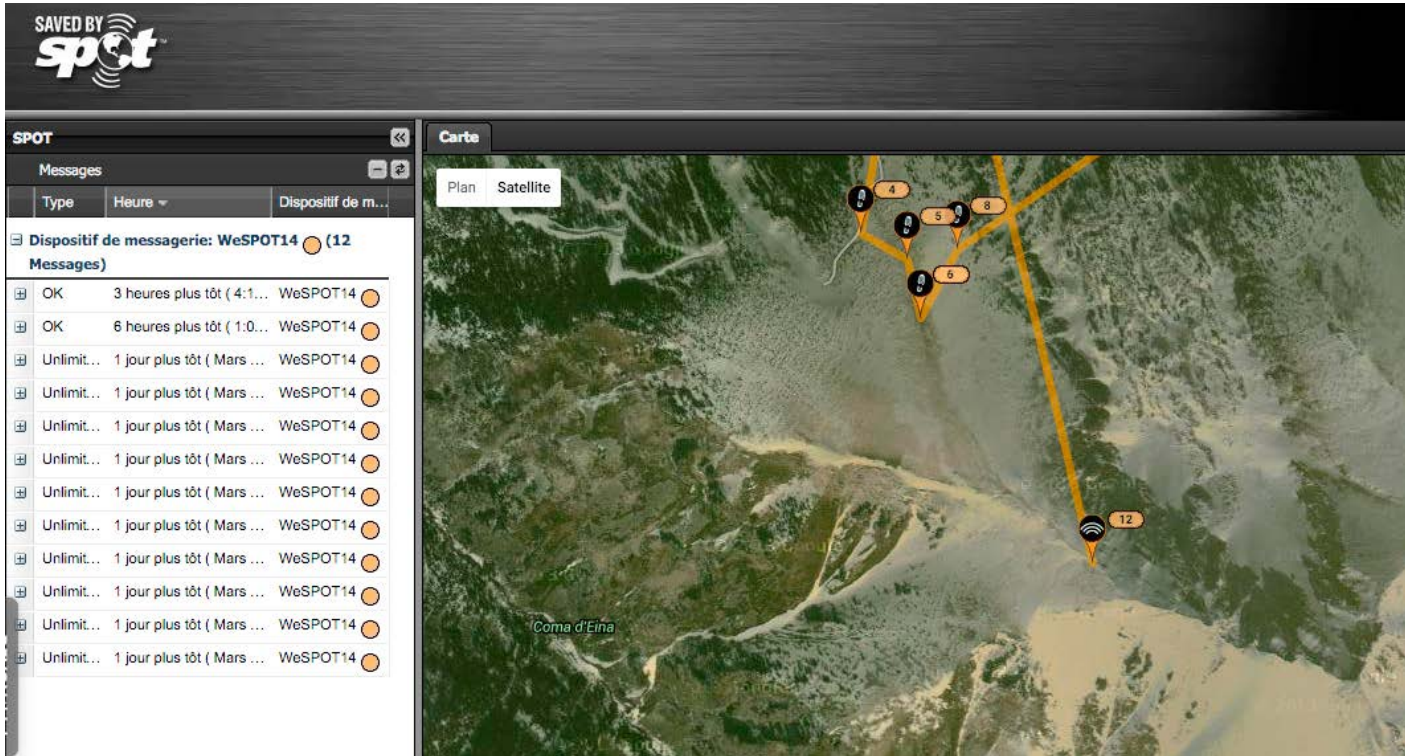

The positions are displayed on a map. It is also possible to automatically post all the 'OK' messages with their position on a news thread on Facebook or Twitter. The French service provider offers extra services like tracking in competitions. For example: <http://soaring.fr/pyrenees-air-tour-2016--marche-et-vol-5239>

The 'Help' and 'SOS' buttons are hidden and protected by a cover.



**ADVANTAGES:**

- The least expensive system
- Simple.
- Very light
- New: configuration by USB
- Extra battery life thanks to a vibration detector which puts the instrument on stand-by when stationary.

**DISADVANTAGES:**

- Sends only predetermined messages
- Can't receive messages, no confirmation that out-going messages have been read.
- Lack of global coverage.
- Altitude not transmitted.

We tested the first SPOT in 2008, after which lots of pilots started to use them. Left, the SPOT 1 in 2008, in the middle the SPOT 2, and on the right the current SPOT 3 tested in 2016.



Photos: Véronique Burkhardt / voler.info

# DELORME INREACH SE



The Delorme inReach SE tracker which we have already reviewed in our magazine is an instrument which has been widely tried and tested. It is on sale for 320 €, it fits perfectly into a cockpit and weighs about 190 grammes. There is a subscription which starts at 15 €, but the most useful one (the Recreational Plan) for regular use (each lone flight) with unlimited tracking every 10 minutes, costs about 22 €, depending on the dollar exchange rate.

The tracking and the messages are transmitted via the Iridium satellite network, which works everywhere in the world. But above all, it works in both directions: the pilot can receive actual texts by SMS and by email. He can also send the web link of his current track log to any email address or mobile number in the world so that other people can follow him, even if this wasn't thought of in advance.

Linked to a smartphone (iOS or Android), the Delorme allows messages to be written and read very easily. 📧

The systems based on the Iridium network (Delorme and YBTRacking) cover the whole globe because the satellites even pass over the poles.

Below: the actual tariffs when you subscribe directly with Delorme. The company Delorme was recently bought by GARMIN. It is not yet known what the consequences will be for future tariffs.



	Safety Plan	Recreation Plan	Expedition Plan	Extreme Plan
SOS	Unlimited	Unlimited	Unlimited	Unlimited
Text Messages	10	40	Unlimited	Unlimited
Preset Messages	Unlimited	Unlimited	Unlimited	Unlimited
Tracking Intervals	10 minutes+	10 minutes+	10 minutes+	2 minutes+
Tracking Points	\$0.10 ea.	Unlimited	Unlimited	Unlimited
Location Pings	\$0.10 ea.	Unlimited	Unlimited	Unlimited
Monthly Charges				
Annual/Contract	\$11.95 /mo.	\$24.95 /mo.	\$49.95 /mo.	\$79.95 /mo.
NEW Freedom Plan	\$14.95 /mo.	\$34.95 /mo.	\$64.95 /mo.	\$99.95 /mo.
Overage Charges				
Messages (each)	\$0.50	\$0.50	N/A	N/A

**ADVANTAGES:**

- Works everywhere in the world
- Two way communication with acknowledgment of receipt by the system
- It can send and receive SMSs and send emails
- Write messages on the instrument or on a smartphone
- All the settings can be adjusted in the field
- Fairly light

**DISADVANTAGES:**

- More expensive than a SPOT tracker

The setup as well as reading and writing text messages can be done directly on the instrument, or otherwise, a lot more comfortably, via a smartphone using a Bluetooth connection.

The tracker is supplied by a rechargeable battery. The battery life is about a hundred hours when continuously tracking (1 position per 10 minutes).

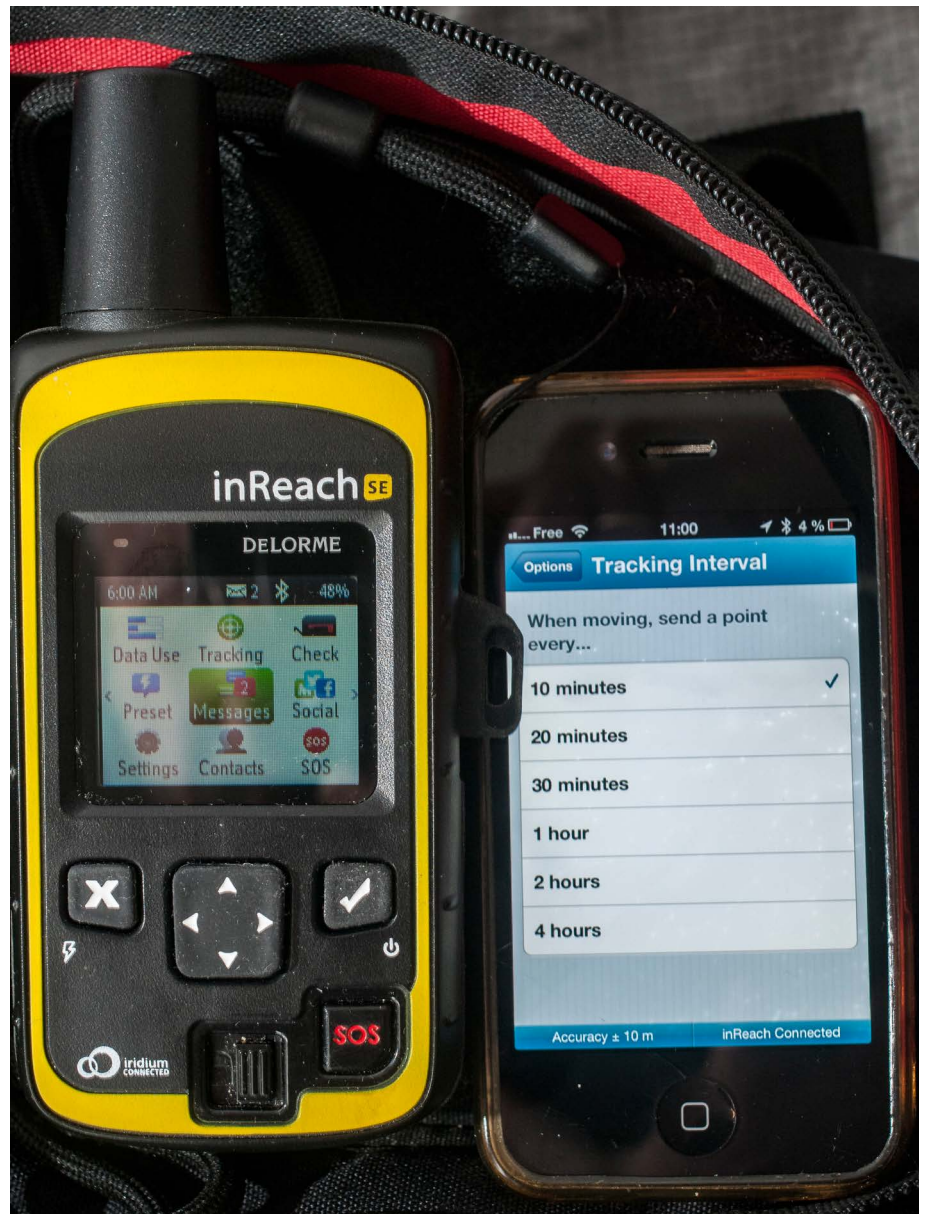

InReach hike and fly type tracking: reliable and precise.





# DELORME INREACH EXPLORER



**T**here is an even more elaborate version of the Delorme inReach SE: The Explorer comes with some interesting extra functions. In addition to the GPS, which is of course present in all the trackers, it also has, amongst other things, a barometric altimeter as well as an electronic compass and navigational functions. It can therefore be used like a normal GPS for navigating to a waypoint or following a route.

The main attraction: when the instrument receives a message with the coordinates of another pilot, for example, you can ask the Explorer to guide you to this point. A map shows all such way points; it rotates to match the orientation of the instrument. The instrument can also record a track log in GPX format and import files containing waypoints. These are therefore typical functions of a hand held GARMIN GPS.

They can also be accomplished by a modern smartphone, so you don't really need one, but it is a lot more practical to have an 'all in one', particularly in a group of pilots. With a price of 412 €, the difference compared to the SE version, is nearly 100 € - the choice is yours. ✂

**Range 2016**  
**\*Made in France**

[www.trekking-parapentes.fr](http://www.trekking-parapentes.fr)

**Senso**

\*2290 €

**Sport**

\*2650 €

**Trek**

2650 €

**Just One**

\*1750 €

**BBUS**

2850 €



**ADVANTAGES:**

- Integrated navigational functions.
- Works all over the world.
- Two way communication with acknowledgement of receipt by the system.
- It can send and receive SMSs and send emails.
- Write messages on the instrument or on a smartphone.
- All the settings can be adjusted in the field.
- Fairly light.

**DISADVANTAGES:**

- More expensive than a SPOT tracker.
- More expensive than an inReach SE.



Photo: Sascha Burkhardt

The inReach Explorer offers all the functions on the inReach SE with, in addition, a 'Goto' navigational aid with a graphic display of the track log and messages on the screen.

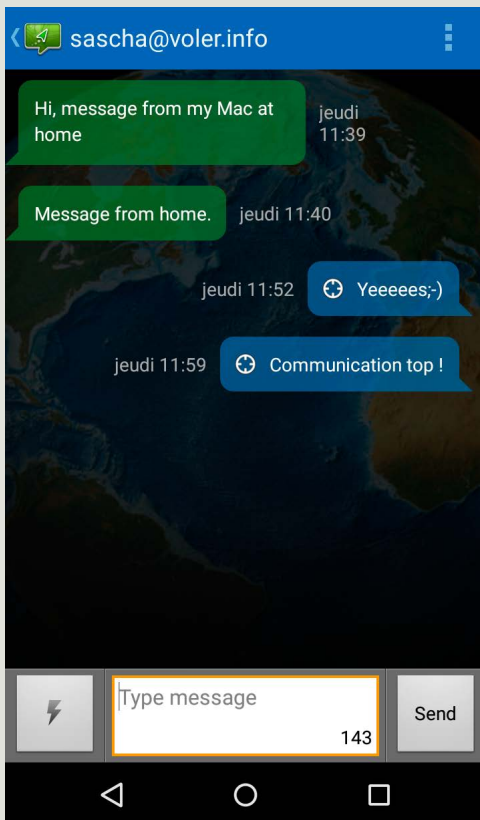

Whether for the inReach SE or for the inReach Explorer, the Android applications for the iPhone make reading and writing messages easier. It also lets you visualise the actual track log on a map, on condition that this has been downloaded in advance for the region concerned.

For Delorme subscribers, people who want to contact the pilot must enter their first message via the Delorme site.

The pilot needs to send an SMS first; only then is it possible to reply to him. From then on, that number can be used to continue communicating with him, as with a normal SMS chat, and will last for about three months. Afterwards, the reply number is recycled and you need to have another initial contact via the web site.

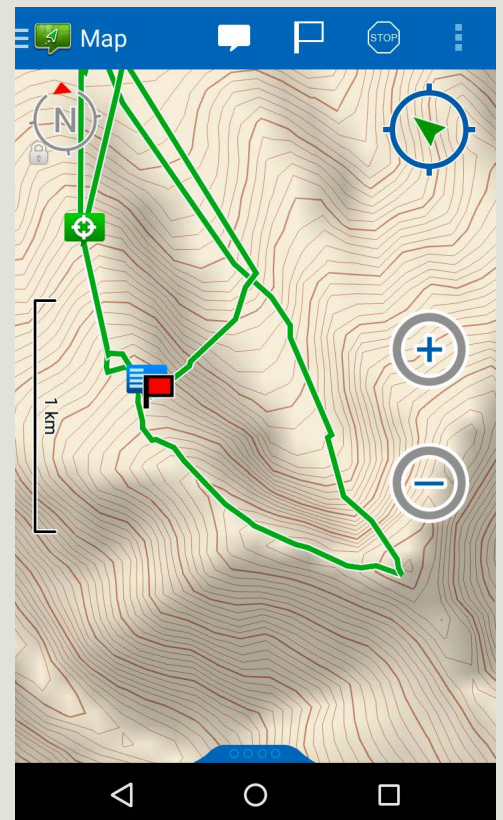
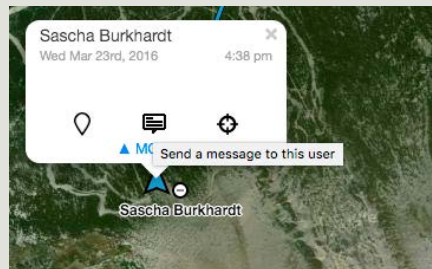

**Search Session**

Session name:  min Duration:

---

**Session Info**

Name: **3103** Device: **300434061905770**

Start: **31/03/2016 17:34** End:

Length: Duration:

First Signal: Last Signal:

Interval: **600 s** Altitude: From to

Max Speed: Avg Speed:

---

**Messages**

Last Event

Drops: **0 lost signals**

Fence:

Timestamp:

Latitude:

Longitude:

Altitude:



The two Delorme instruments (0) and (1) are in the blue rest zone designated in advance. As soon as they leave it, functions like 'alert if no movement' are activated. There is also an alarm if any of the instruments leaves the red perimeter.

The German company Global SafeTrack Systems specialises in marketing satellite trackers. They also market Delorme inReach instruments and sell them to individuals. Their great strength is in having established specific contracts with Delorme and having built a whole tracking system around this offer. Pilots who take out a subscription with them can define a group of Delorme instruments which will all receive certain messages at

the same time. It is possible for example to define 'Geofence' zones: if one of the participants leaves the perimeter, all the others are alerted and can navigate towards him.

Conversely, it is also possible to define collective alarms if one of the instruments stops moving, very useful if a solo pilot crashes.

<http://www.gpsafety.de/english/>

## full range of freeflying & paramotor wings



## IMPROVED SOFTWARE

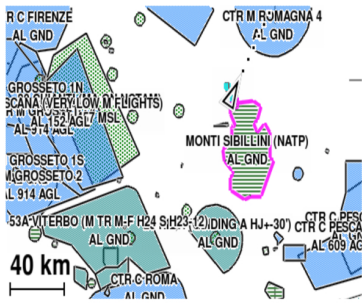

free download from the web; customization and management

AIRSPACES

## IMPROVED MAPS

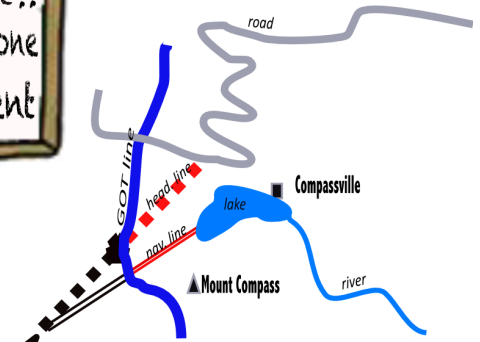

Cities, rivers, lakes, names and altitude of mountains

NEW TOPOGRAPHIC VECTORIAL MAPS



## LONG LIFE BATTERY

NAVIGATION BY TOUCH



## ALL-IN-ONE

## NEW HARD GLASS

XC ASSISTANT & TRIANGLES

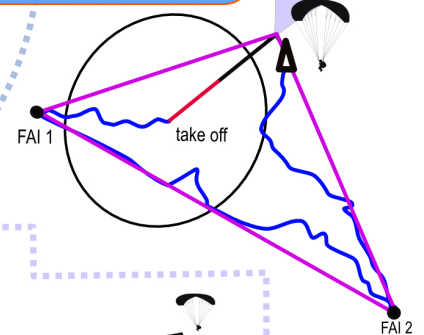

GLIDE OVER TERRAIN



choose a "goto" by a simple touch in the map. Move and zoom the maps

watch in real time where and at what altitude your transition will end considering the terrain: crossing is much more easy!

not only triangles ... a complete XC Assistant to give you all the informations needed

# The XC - INSTRUMENTS

Designed for the Cross Country Pilot  
We give you all the data to let you take the best decisions



# YB-TRACKING YB3



**T**wo years ago we tested the Yellow Brick Tracker. Its successor called the YB3, is almost identical. 'Yellow Brick' is perhaps too brick like, and indeed it is heavier than the Delorme. It works using the same Iridium satellite system, thus giving worldwide coverage.

Its principal is the same, but from the outset it offers more possibilities than a Delorme, especially if the YB3 is controlled by a smartphone via Bluetooth. The application is very well produced, and it allows lots of adjustments, such as an alert when a certain ambient temperature is exceeded.

The instrument also offers an automatic alert function in the case of a prolonged lack of movement (in the case of a crash for example), an integrated service which on other instruments, such as the Delorme, must be adjusted through the server.

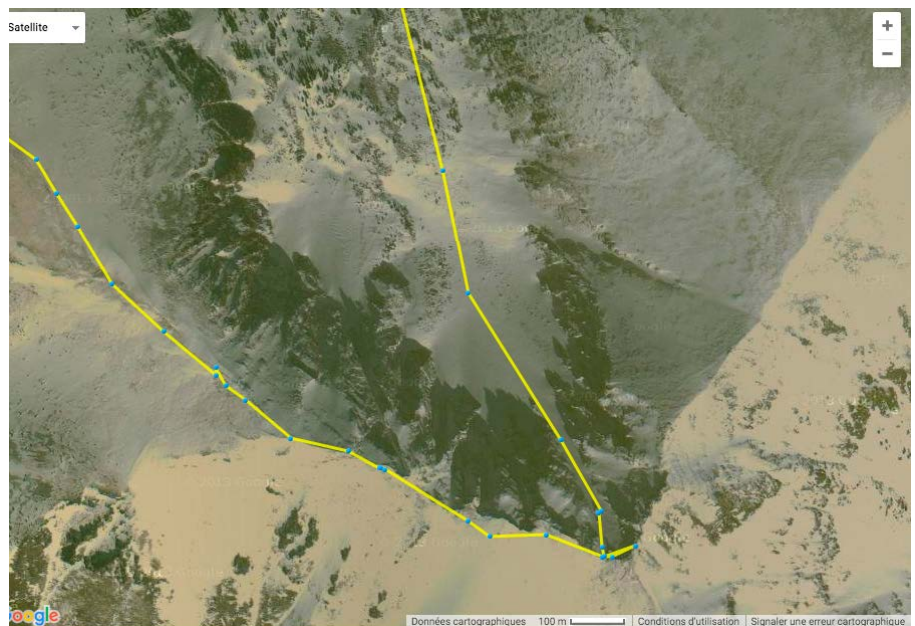

Precise tracking. Theoretically, you can adjust it to the resolution of one tracking point every 5 seconds, but that would be very costly.

It's certainly an interesting tracker which with an impressive battery life (3 weeks of uninterrupted tracking at a rate of 1 point every 15 minutes), but it is more expensive as well as heavier and bulkier. It costs upwards of about 600 €, monthly cost 11.50 €, with an extra cost of about 0.15 € for each tracking point. But you can hire it on a temporary basis.

[www.ybtracking.com](http://www.ybtracking.com)

**ADVANTAGES:**

- Works all over the world
- Two way communication with acknowledgement of receipt by the system
- Sends and receives SMSs, sends and receives emails
- Lots of adjustments possible
- Integrated geofencing

**DISADVANTAGES:**

- Fairly expensive
- Heavier and bulkier

This instrument works on its own but it is optimised to be used in conjunction with the excellent application for smartphones. Its Bluetooth connection is now 'Low Energy', so it is more economical on energy.

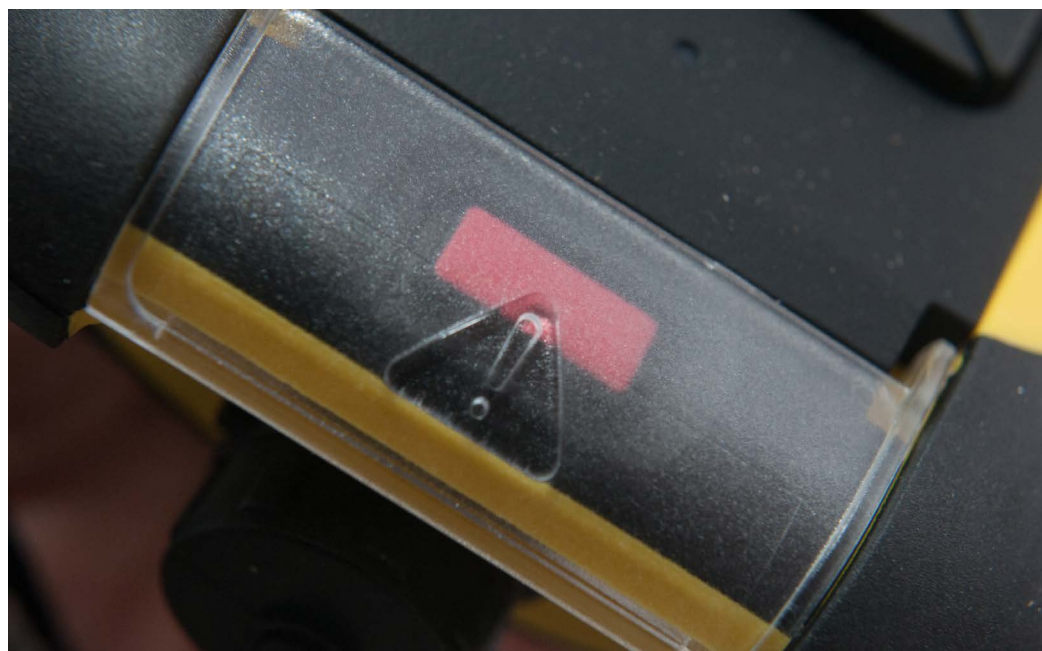
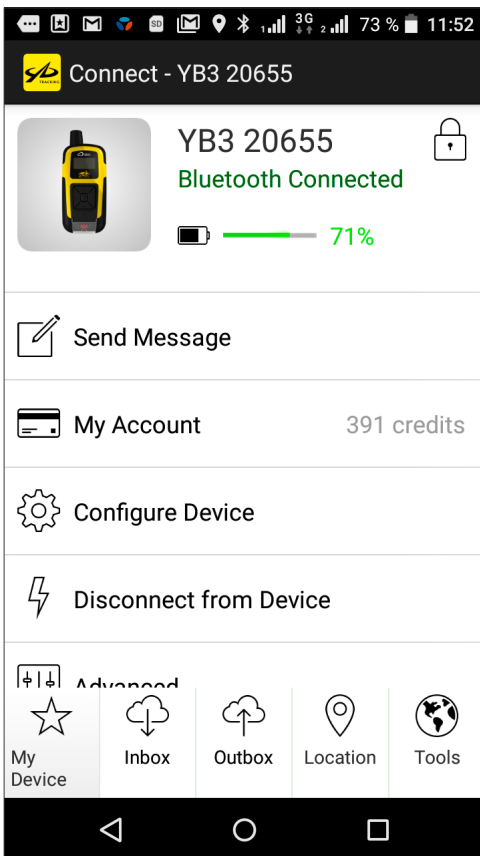



ARE YOU  
**ready**  
to touch  
the clouds?



Si oui  
**Yes**  
I am.  
Ja

new! even lighter!  
**Wani light, 2.6 kg (L)**  
[www.woodyvalley.eu](http://www.woodyvalley.eu)



An Ozone LM5 in India (photo: Olivier Laugero). In this type of area a satellite tracker is even more essential.

#### D-S-X SAFLY

We tested the DSX-Safly in 2011. The instrument tracked just as well by satellite as by GSM, depending on the availability of the network. It's a very good idea. It is also compatible with LiveTrack 24. At the same time it is an IGC recorder.

For the last few years the company has become oriented more towards the professional market and their tracker no longer seems to be available.

<http://www.d-s-x.it/>

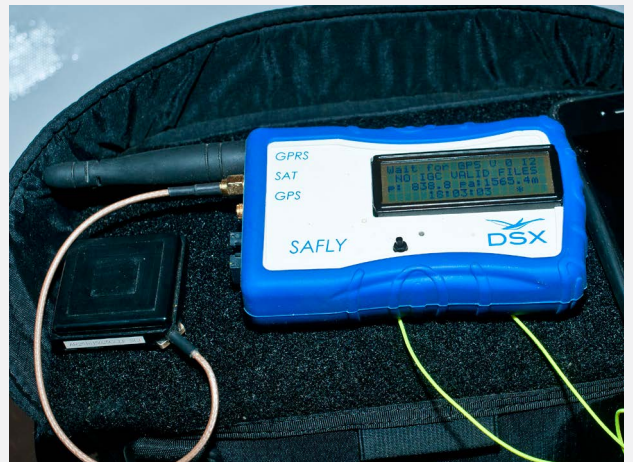

# MEASURING THE WIND

*Knowing the exact wind strength at take-off even though there isn't a windtalker, is an important safety measure.*

*And in flight, the air speed can be useful if you really want to know your paraglider...*



Nearly thirty years of good and loyal service: the first Skywatch anemometer which showed us if the wind was too strong to take off on a Brizair with ten cells...



Photo: Sascha Burkhardt

A Bulgarian pilot testing the air at take-off.

# SKYWATCH ANEMOMETERS



**A**t Skywatch, measuring the wind and meteorological parameters is the main activity. Their top of the range instrument, the Geos N°11 is certainly a bit heavy, but it is a real pocket weather station. In addition to wind strength, the instrument displays humidity,

temperature, dew point, atmospheric pressure and it also has a compass. A scientifically precise instrument, as promised by the manufacturer, it is even used by the army. On the other hand, it isn't very intuitive to use and its price is very high: 450 €.

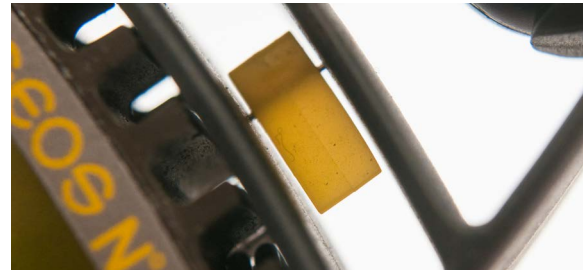



INSTRUMENTS

Fortunately the manufacturer has instruments which are a lot less expensive on offer: the Skywatch Xplorer range. The entry level model, the Xplorer 1, weighs 50 grammes, costs about 40 € and only measures the wind strength. For use at take-off that is amply sufficient.

The Xplorer version 2 also displays temperature, the Xplorer 3 includes an electronic compass, and the version 4 adds atmospheric pressure.

Price of the Xplorer 4: 100 € approx. ⚠

[www.jdc.ch](http://www.jdc.ch)



**APCO AVIATION**

**GAME 42** NEW

A masterpiece in the sky  
Enjoy the flying precision and World Class performance of this new tandem wing.  
Long lasting, yet light, a beautifully balanced package that flies and performs as a fine tuned solo wing - It will win you over on your first flight!

• Fully certified EN / LTF B

**SETTING FUTURE STANDARDS**

1974 APCO launches serial production of hang gliders

1986 1<sup>st</sup> generation paraglider hits production

1995 Bagheera the glider of champions

2004 1<sup>st</sup> paramotor world records

2016 GAME 42 the latest creation



T-40

T-30

T-20

T-10

NOW



# WINDOO 1, 2 AND 3



The Windoo is made by the same manufacturer as the Skywatch, the Swiss company, JDC. The idea was to offer a small accessory compatible with iPhone and Android phones, allowing the wind speed to be measured any time, any place. And not just that: in the more

elaborate versions, the instrument becomes a full weather station with wind speed and direction, temperature, humidity and atmospheric pressure. It is impressive to see how the manufacturer has managed to fit all that into this little aluminium tube. The instrument fits into

the headphone jack and communicates via the microphone input with a specialised application which needs to be downloaded beforehand. It gives all the readings shown on the telephone screen.



**Fly safe**

certika.org - Tél : 04 58 10 01 59



**CERTIKA**

# WINDOO

The instrument worked well during our tests and gave consistent measurements. For the wind speed, the manufacturer promised an accuracy of  $\pm 2\%$  within a range of 3 km/h to 150 km/h. The only drawback we could find is that you need to have a close look at the list of compatibilities because lots of phones aren't, even amongst recent models (<http://windoo.ch/en/compatibilities>).

The first model, which is without a doubt sufficient for most pilots, costs about 60 € and the more elaborate ones about 100 €. [www.windoo.ch](http://www.windoo.ch)

It is also possible to share the measurements with other users via the telephone's Internet connection. The measurements from other users are visible on Google Maps (on the telephone screen as on the web).

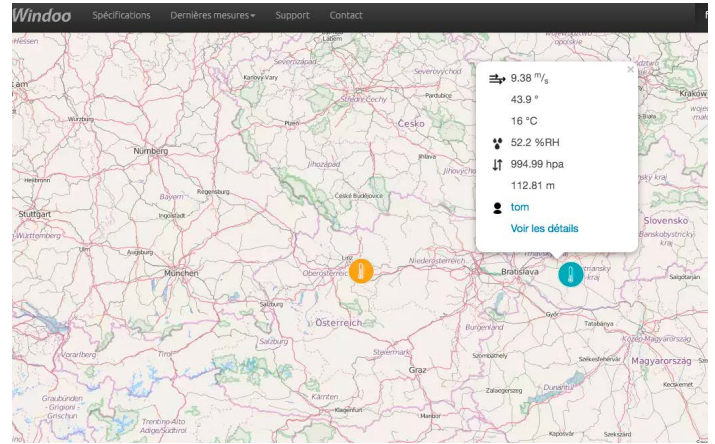

The rotor is well protected in the tube.



	⇒	📍	☁	↕
Windoo 1	✓	✓	✗	✗
Windoo 2	✓	✓	✓	✗
Windoo 3	✓	✓	✓	✓

# VAAVUD SLEIPNIR AND MJOLNIR



**V**aavud was one of the first to offer an instrument to measure the wind which plugged into an iPhone: the Mjolnir was the pioneer. It's an anemometer with cups. The audio jack only serves to fix the instrument onto the telephone; there is no electronic transmission. It's all done using small magnets integrated into the wheel, which move in a cyclic fashion in the magnetic field around the telephone and allow it to measure the number of rotations. The application installed on the telephone (Android or iPhone) works out the wind speed within a range of 7.2 km/h to 72 km/h (4% accuracy). The Mjolnir, which came out before the Skywatch Windoo, is very bulky compared to the latter. On the other hand, it is almost indestructible. It costs about 40 €.

Then Vaavud brought out the Sleipnir. It is smaller and functions differently, the speed measurements are transmitted by the microphone socket. It still measures with 4% accuracy, but goes up to 144 km/h.

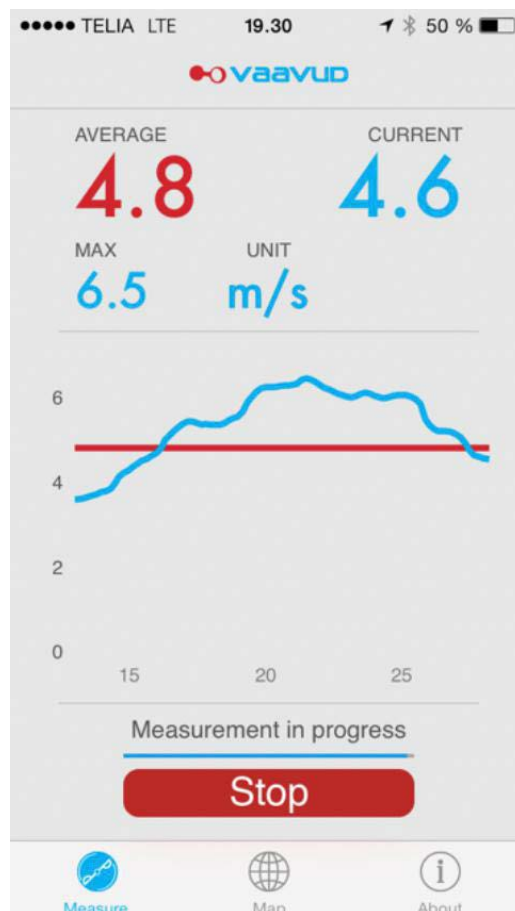

The application displays the wind speed on the screen and produces a nice graphic of the last few minutes. It is also possible to transmit the data onto a community website and to consult the values given by others.

On the other hand, the two Vavuuds measure neither the temperature, nor the humidity, nor the atmospheric pressure, as do the top of the range Windoos. And even the Sleipnir remains bulkier.

Check the compatibility of both instruments carefully with your smartphone, it's limited. Sometimes, it can work, but there is no guarantee: an Acer Liquid for example, not mentioned in the list, worked before the last Android upgrade, but not afterwards...

<https://vaavud.com/compatibility/>  
[www.vaavud.com](http://www.vaavud.com)  
 and also on [www.paratroc.com](http://www.paratroc.com)

The Sleipnir transmits the number of rotations by the slot for the microphone on the smartphone. It costs 55 € and weighs about 13 grammes. List of compatible smartphones: [www.vaavud.com](http://www.vaavud.com)

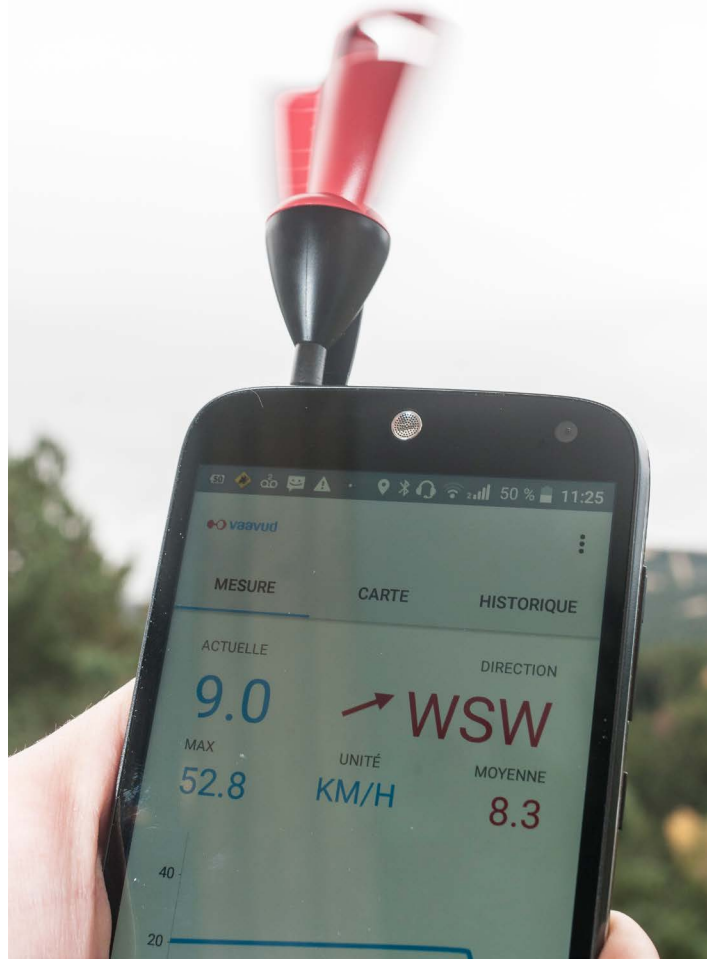

Photo: Sascha Burkhardt

The Mjolnir uses magnetic fields to transmit the number of rotations to the smartphone. It weighs about 15 grammes and costs 40 €. List of compatible smartphones: [www.vaavud.com](http://www.vaavud.com)



# AIR SPEED PROBES

*Air speed probes for top of the range variors can be used at take-off to measure the wind in the same way that they measure speed in the air. Two examples: Compass and Flymaster's pitot tubes.*

**B**oth are real pitot tubes which calculate air speed by measuring the increase in pressure caused by the air flow. They are therefore aeronautical instruments which measure IAS, (Indicated Air Speed). The difference lies in, amongst other things, the number of extra sensors which have been integrated as well as in the processing of the information.

#### TRUE OR INDICATED SPEED?

Remember: pressure anemometers such as the pitot tube measure speed by measuring the pressure of the air flow. For a paraglider flying hands up, it therefore always shows the same value whether at sea level or above Mont Blanc. Obviously the paraglider will fly faster at the height of Mont Blanc because, in less dense air, you have to go faster to reach the normal pressure against the profile, but the dynamic pressure, in other words the IAS, remains the same. It's the IAS speed which is interesting if you want to compare two wings, even if progression through the air (and over the ground) isn't the same as a function of the altitude.



Photo: Sascha Burkhardt

For orientation in the airflow, Flymaster give a tolerance of  $\pm 20^\circ$  - inside these limits, the error is negligible. We noticed in fact that, during our tests, the speed indication seemed very stable and reliable throughout the whole flight, even when the probe was attached to the risers, as on this paramotor.

Instruments with cups or blades like the Skywatch or the Vaavud give the real speed, close to the True Air Speed or TAS: at an altitude of 2000 m, they show 55 km/h instead of 50 km/h for any given paraglider. Their reading is independent of the pressure, because the dynamic pressure of the wind is compensated by the aerodynamic force due to the air flow created by the movement. Therefore the measurement corresponds to the real progression of the paraglider in the air, and approximately to that which can be read on a GPS if there is nil wind.

Instruments equipped with pitot probes recalculate from IAS, taking into account the altitude, the same 'true' flying speed (TAS) and allow it to display the two speeds by choosing one, or both at the same time.

Compass Instruments have made, with their C-Probe, an instrument in its own right. Bedecked with sensors, it even includes humidity, roll, pitch and acceleration of the instrument in the calculation, to eliminate any disturbance due to the pilot and air movement.

Flymaster make do with measuring the dynamic pressure (IAS) and acceleration. The manufacturer points out that during a flight at 40 km/h in an air mass at 20° and pressure of 1 013 hPa, the difference between a humidity of 0% and 100% will only change the speed calculated by 0.18 km/h, which is negligible.

But Flymaster also don't measure movements of the instrument nor its position compared to the pilot. The IAS is recalculated in TAS and displayed on the screen of the Flymaster instrument. ☹

**SCHÉMA D'UN TUBE DE PITOT**

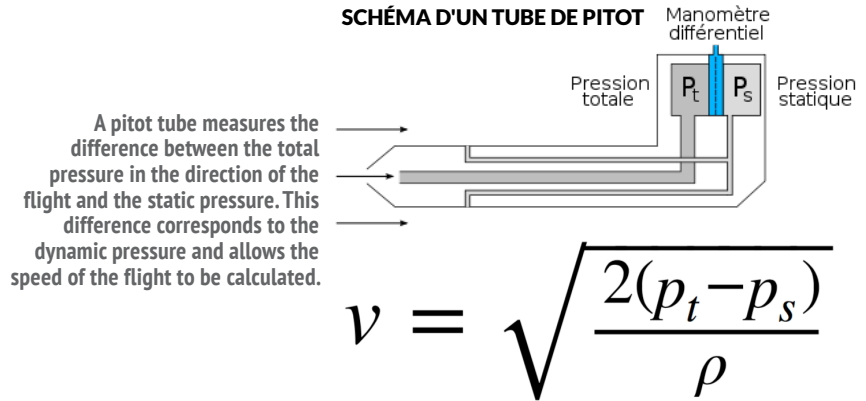

Dessin: Dr. Wessmann

The Flymaster probe is fed by a 1.5 V battery. The cordless instrument communicates with all the recent Flymaster instruments by transmitting to them via RF (not Bluetooth) speed and temperature. It weighs 232 g and costs 150 €. [www.flymaster-avionics.com](http://www.flymaster-avionics.com)



The opening on the Flymaster pitot tube.



Photo: Sascha Burkhardt

# COMPASS C-PROBE



The Compass C-Probe pitot tube doesn't just give the dynamic pressure which is used to calculate IAS but also information from a:

- Thermometer
- Gyrometer, 3 axes
- Accelerometer, 3 axes
- Compass (electronic), gyroscope stabilised
- Hygrometer

All this information is supposed to allow the instrument (compatible with all the recent Compass range) connected by Bluetooth, to better calculate and know, taken from the true air speed:

- The speed and the direction of the wind even when flying straight without turning

Compass recommend attaching it to the cockpit in front of the pilot, which orientates the tube as a function of the angle of the flight deck. Great, much more practical than a pitot tube dangling under the pilot...



Photo: Saschia Burkhardt

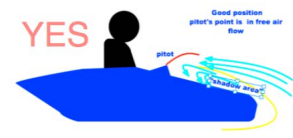
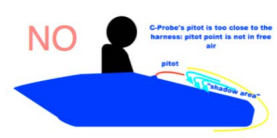
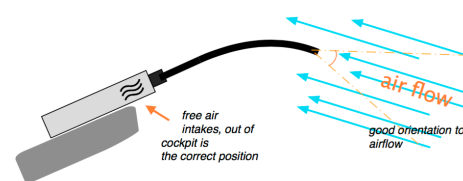

Dessins: Compass-Italy



- The actual glide ratio
- The expected height of cloud base (after a few turns in the thermal)
- The optimal speed to fly in a competition or during an XC

The secret of Compass's success lies in the algorithm developed to make the necessary corrections. To go from IAS to a TAS value via CAS 'Calibrated Air Speed', which takes into account the disruption to the flow around the pilot and parasitic movements, the manufacturer uses all four extra sensors.

This is the only way to get values which can be used to measure the polar curve of a wing or to optimise the speed to

fly for XC. According to Compass, the performance of the sensor/algorithm combination was validated in the wind tunnel at the Institut Supérieur de l'Aéronautique et de l'Espace at Toulouse.

The aim of this visit by the Italians was to demonstrate to the French Air Force the performance and precision of this sensor. Following that, the army ordered a special version of this instrument (right) to equip planes, the exact nature of which remains confidential.

In summary, it's hardly surprising that the C-Probe costs as much as a small instrument: 399 €. [www.compass-italy.com](http://www.compass-italy.com)



Luca Basso from Compass Italy with the special version which uses similar algorithms.

The air entry on Compass's C-Probe pitot tube.



Photos: Sascha Burkhardt

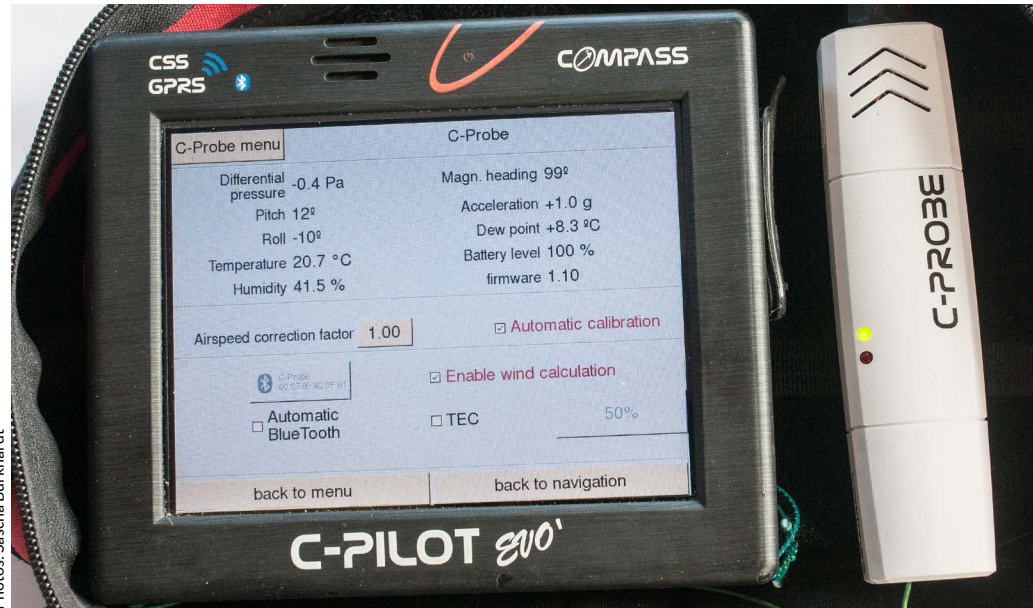

The C-Probe contains numerous sensors, whose precise values are displayed here on the instrument. They serve, above all, to give the data to correct the probe, necessary due to its position in the disrupted air flow.

On/off button, USB socket, serial port jack and openings for measuring temperature, humidity and pressure around the instrument.

Photo: Veronique Burkhardt





# POLINI THOR 80, SMALL BUT POWERFUL.

POLINI THOR 80 is a real heap of technology. From the Polini engineering experience a new revolutionary engine is born, which combines surprisingly compact dimensions, extreme lightness, a powerful thrust and lifting power abilities. With its capacity of 86cc and its power of 17,2hp at 10.450rpm, POLINI THOR 80 is the ideal choice both for the beginners who approach the world of flight and for the aeronautic lovers who can trust on extraordinary performing qualities and reliability.

POLINI THOR 80. Small in its shape, big in its essence.



**polini** motori<sup>®</sup>  
*trasforma il meglio in massimo*



As far as screens are concerned, a major improvement has been made in their readability. Some have managed to happily combine good luminosity, good anti reflection capacity and bright colours, sometimes even adding a touch-sensitive layer...

# INSTRUMENTS THE NEW GENERATION

*Over the last two years there has been a lot new in the instrument market. We've tested most of them. Before going through them, a new function adopted by several manufacturers deserves a more detailed explanation: the integration of artificial horizon technology.*

Both in weak conditions and in competitions, pilots try to optimise their search for thermals. Sensors like the gyrometer and the accelerometer are now integrated in the calculations in varios.

# GYRO-VARIO

NEW SENSORS AND ALGORITHMS  
TO FIND THERMALS?

To correctly know your position, to understand and measure all movements so that you can optimise a climb, the barometer, which is the essential sensor on any vario, is perhaps not enough. Several years ago, the manufacturers started integrating measurements from gyrometer, accelerometers and magnetometers. The gyrometer records the rotations on all the axes, the accelerometer the accelerations and the magnetometer is nothing other than an electronic compass. If you combine these values with a suitable algorithm, you will be able to see the position of the aircraft at any time. You can then, amongst other things, use this information to create an artificial horizon or Attitude Heading Reference System (AHRS), which isn't normally that useful on a paraglider or paramotor.

You can also do without a GPS. If you know the initial position of the aircraft before taking off, then by adding, all along the flight, all the movements on the three axes as well as all the accelerations (forwards, downwards or sideways), you can recalculate your trajectory and position it on a map of the Earth. That's how commercial airlines used to navigate using their inertial systems before the late arrival of GPSs into their navigation systems (well after us sports pilots with our GARMIN 38s and other Top Navigators).

A chip, like the one used in the XC Tracer, contains an accelerometer on three axes (above), a gyrometer on three axes (middle) and a magnetometer like a compass (below).

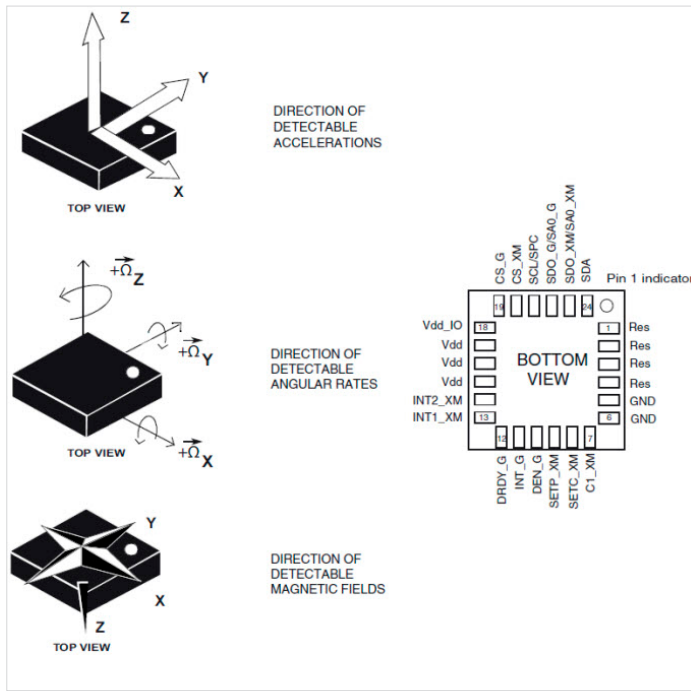

An artificial horizon calculated by an iPhone: all the parameters from the gyrometer, the magnetometer and the accelerometer are integrated in a complex algorithm.

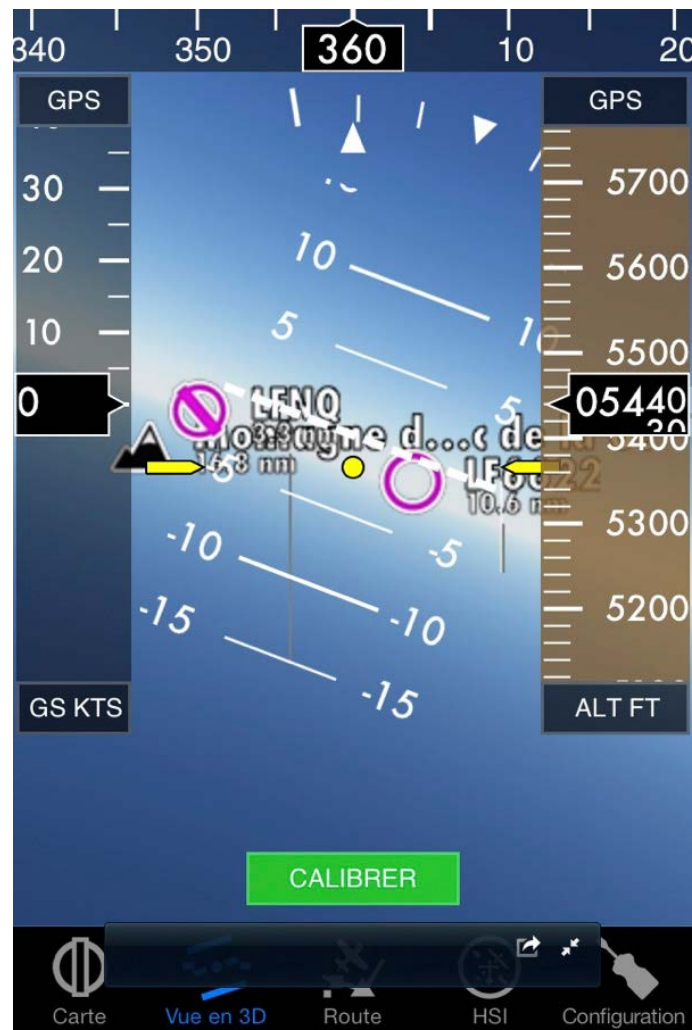

Certain applications for iPhones and iPads serve as gyroscopes by integrating the values of the gyrometric sensor. Note: a gyrometer gives the angular speeds of the rotations around the three axes and the gyroscope works out the orientation of the aircraft.

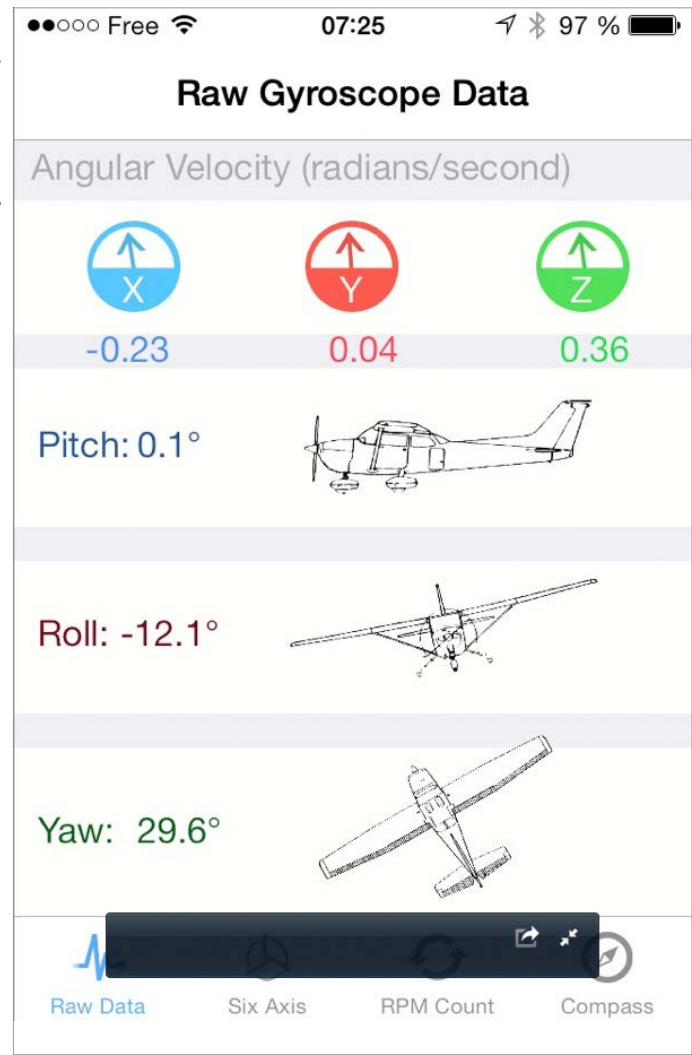



A vario being used by an ornithologist: the Sensbox registers all the parameters of this eagle's flight.

For us, all this seems of little interest. On the other hand, using all these sensors to improve the readings from the vario, now that's a good idea.

When we enter a thermal, well before we start to really climb, lots of things happen: the wing hits against the thermal, we pendulum forwards, and at the moment when we start to go up, there is upwards acceleration which can't be measured straightaway in centimetres or metres gained.

Another advantage of integrating all the sensors is the refinement of the measurement of the wind speed and direction. The company Flytec/Bräuniger, for example, has taken part in a scientific project, aimed at understanding the way in which eagles use the wind to optimise their journeys. For this, the birds were equipped with a Sensbox. It's the instrument, still in the Flytec catalogue,

which was used to develop the Connect from the same manufacturer. The Sensbox was used because it was one of the first light and compact flying instruments to record all the values necessary to measure all the flight parameters of these birds. IAS was measured by an external sensor connected to the Sensbox.

Flytec have therefore got lots of experience of measuring all the parameters and their integration into algorithms, but the Swiss manufacturer has decided for the moment not to integrate the accelerometer into the vario calculations.

Yet other manufacturers have gone down this road, amongst others, Swiss Koni Schafroth with his XC Tracer. His idea was to use the gyrometer, compass and accelerometer in an algorithm like that for the artificial horizon, with the aim of improving the performance of the vario.





It's particularly in weak thermals that the combination of barometric sensor and gyroscope have turned out to be effective. The XC Tracer by Koni Schafroth has proved this: it's a fantastic help in saving a flight which is about to end up on the ground.  
Photo: Loren Cox



[www.papteam.com](http://www.papteam.com)

By signalling the start of a climb in a thermal as soon as the system of sensors notices upwards acceleration, it does, without a doubt, save at least a second. In fact, if you compare the XC Tracer with a normal vario, it beeps earlier. The difference is even greater coming out of the thermal; as soon as you leave it the beep stops straightaway, whilst a normal vario continues to beep. The pilot can thus be more efficient, but it's especially the case in weak conditions. In strong thermals there is only a small advantage.

Other manufacturers, whose instruments already contain at least one accelerometer, have offered firmware upgrades to make use of this value. Flymaster and Syride call this 'an instant vario'. But the enthusiasm isn't unlimited. Certainly during a free flying trade show, at the manufacturer's stand, the demonstration showing the reaction speed is always very convincing.

But in the air it is less spectacular, as the gain can only really be felt in weak conditions. In addition, manufacturers working only with the accelerometer must do even more 'filtering' to avoid false climbs, which can even be counterproductive.

At manufacturers like Koni Schafroth the algorithm which takes into account all the sensors is very complex. It has no doubt still got potential to improve, even though it is already undeniably very high performance.

At other manufacturers like Compass and Flytec, whose instruments possess all the sensors necessary for an AHRS, they want to do more work on the algorithms before integrating such a function.

Watch this space... ☺



# XC-TRACER

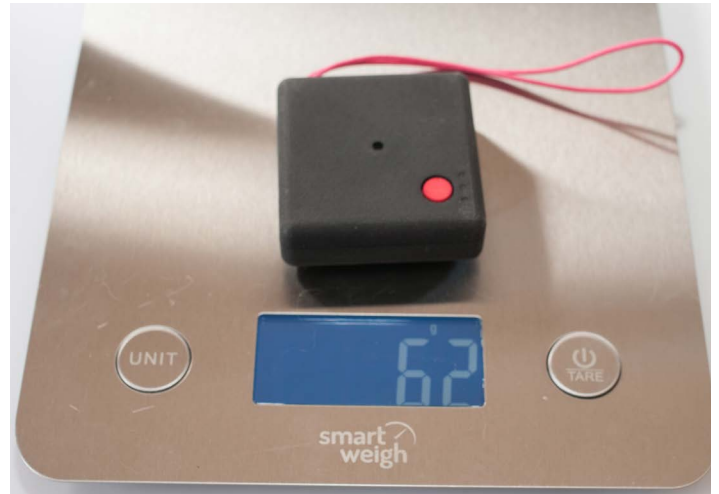

**Size:** 57.5 x 57.5 x 19,25 mm. **Weight:** 62 g.  
**Energy:** Accu LiPo 1200mAh. **Autonomy:** 14h  
**Sensors:** GPS, barometer, gyrometer, magnetometer, accelerometer.  
**Interfaces:** Bluetooth LE, USB, SD.  
**Price:** 295 €.

Since its launch a year ago the XC Tracer has been much talked about. It was launched on the crowd funding website Indiegogo where, by the end of April 2015, it had raised more than 33,000 €, 132 % of the funds necessary. Since then the design has been made more professional and the instrument has sold with great success. A mini acoustic and solar version (not yet tested) has even joined the initial model.

We tested one of the first prototypes from 2015. We noticed that, yes, the instrument reacted a lot quicker, the integration of an AHRS system (see previous pages) with a gyrometer, accelerometer and magnetometer gave an instant reaction as soon as the instrument started to go up. Even more impressive is the speed with which the instrument stopped beeping when it came out of the thermal. When you lose a thermal, we all know that feeling of downwards acceleration often accompanied by the



A button, a loud speaker and some LEDs: hidden behind the minimalist design of this instrument are a combination of sensors, a GPS and a high performance algorithm. Here the box is still a temporary prototype. The instrument communicates by beeping, and also via a Bluetooth LE 4.0 interface.





Photo: Koni Schaefroth

During the winter of 2015/2016, Koni Schaefroth, an experienced pilot who has been flying for twenty five years, optimised the XC Tracer Mini, pictured here in a cockpit next to the classic XC Tracer. Koni Schaefroth is an aeronautical engineer who works on projects for ESA (European Space Agency) as well as for the paragliding manufacturer GIN.

From the spring of 2015 onwards we tested one of the first prototypes of the XC Tracer.

last 'beeps' on a normal vario, which only goes quiet a few seconds later. The XC Tracer on the other hand communicates the loss of the thermal without any delay. Impressive.

The acoustic profile can be modified in a detailed fashion by editing the configuration file. A utility on the manufacturer's website allows you to quickly simulate the values to test it.

But it isn't just an acoustic vario. It communicates via its Bluetooth LE interface with tablets or smartphones like Skylogger (iOS), FlyskyHy (iOS), Thermgeek (iOS), XCSoar (Android, Kobo), TopHat (Android, Kobo), TheVariometer (iOS), FlyMe (Android) and Androflight (Android).

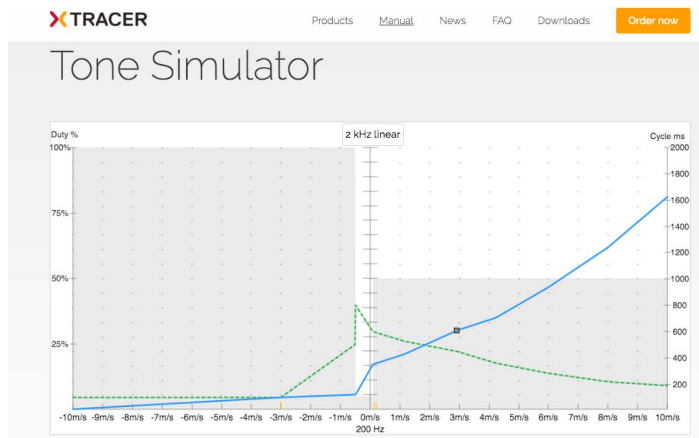

Photo: Sascha Burkhardt

The XC Tracer therefore gives smartphones, with their nice big screens and their processing power, the possibility of knowing the air mass perfectly.

The instrument automatically registers all flights in Google Earth or IGC format. Online servers like XContest accept these files.

On the other hand, the XC Tracer must not be mounted on a helmet as each movement of your head risks disrupting its operation. 🚫



The values of the acoustic profile which have gone into the configuration file can be tested via this utility.

In the beginning, the instrument was based on an Arduino compatible platform.



**XC-Tracer Sensors:** GPS, barometer, gyrometer, magnetometer, accelerometer  
**Energy:** accu 1200mAh LiPo **Autonomy:** 14 h **Weight:** 61 g **Size:** 57.5 x 57.5 x 20.5mm **Price:** 295€.



**XC-Tracer Mini, no GPS (out february 2016)**  
**Size:** 44.5 x 44.5 x 16,5 mm, **Weight:** 30 g  
**Energy:** Solarpanel  
**Sensors:** Barometer, gyrometer, magnetometer, accelerometer **Autonomy:** w/o sun 10h - 12h **Price:** 170 €

# FLYTEC SENSBOX



#### Technical data

**Size:** 62 x 121 x 17,5 mm

**Weight:** 131 g

**Sensors:** GPS, barometer, gyrometer, magnetometer, accelerometer

**Interfaces:** Bluetooth LE, USB, SD

**Price:** 400 €

The Sensbox was the first instrument to integrate all the possible sensors like an accelerometer, gyrometer and magnetometer so that it could record these values together with the GPS track log in an IGC format. It was also the first to communicate these values via Bluetooth LE. The problem was that, when it came out, it was ahead of its time and there were hardly any smartphones which were Bluetooth LE compatible. And as the Sensbox doesn't have classic Bluetooth, it refused to talk to an iPhone 4 for example.

The Sensbox is also usable on its own thanks to its little screen (not touch sensitive). But, above all, it's the ancestor to the Connect which we'll test on the following pages.

The Sensbox is still available and is still very useful for hike and fly pilots, particularly if they have a compatible smartphone. 📶

During the winter of 2012-13, we tested the first Bräuniger Sensbox. This box was revolutionary. It communicated with iPhones from 4s onwards, and with most Android smartphones which came out over the last two years.

The instrument also works on its own as a normal GPS vario. Nonetheless, despite having all the necessary sensors, Flytec don't want to use an AHRS algorithm to produce the sound of the vario.

Photo: Sascha Burkhardt



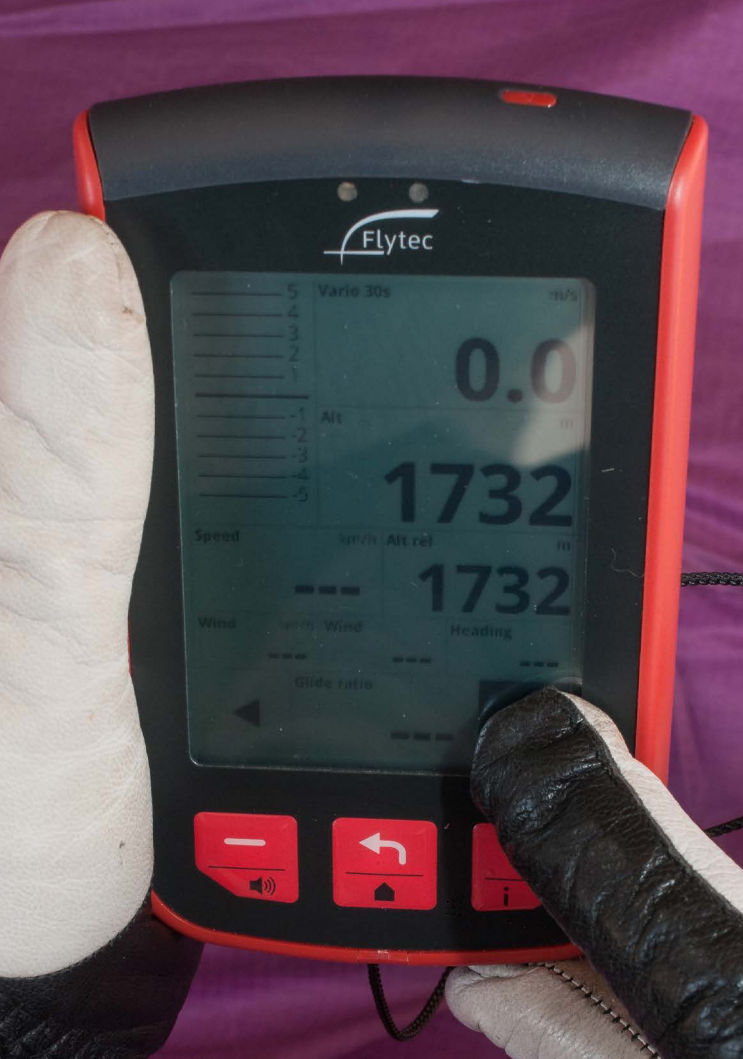

# FLYTEC CONNECT



**T**he Flytec Connect is a Smartvario which is supposed to be a marriage between a small tablet, or even a smartphone, and a flying instrument. Based on the Sensbox, the instrument contains all the sensors possible like gyrometer, accelerometer and magnetometer. A top quality barometric sensor and a GPS are obviously also on board.

A Bluetooth LE chip can be activated by software and there is also a slot for a FLARM anti-collision system.

Bit by bit, with developments and the gradual publication of upgrades, the instrument is gaining functions, but becomes more expensive for pilots buying it afterwards. The problem: following lots of unforeseen factors, development hasn't been as fast as was expected, and the instrument still hasn't achieved the performance of its predecessor, the 6030. All things being equal, a big upgrade should be ready soon.

Competition paraglider pilot Jörg Ewald has been at the helm of Flytec since 2014.



# independence

● paragliding

Paragliding equipment since 1990



PARAGLIDERS



HARNESSES

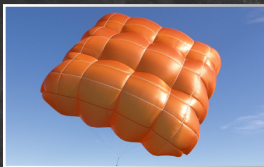

RESCUE PARACHUTES



ACCESSORIES

*fly it your way*

[www.independence.aero](http://www.independence.aero)



Fortunately, all the upgrades work without problems. As its name suggests, the instrument connects very easily, there is an integrated WiFi interface and it looks for updates automatically if allowed to. For certain uploads such as airspace, a USB cable is required, but in future versions, this will also be done by WiFi.

In addition, unlike their older instruments, when connected by USB, the Flytec Connect behaves like an external hard disc, so there is no difficulty connecting

The greyscale screen is perfectly readable, particularly in the sun. It's touch sensitive and it works even with gloves, contrary to the screens on most smartphones. It is very quick and intuitive to use. Three real keys make the interface easier to use. It's all well thought out and works smoothly. Navigation towards waypoints works just like following a road.

We're therefore looking forward to seeing the next upgrades such as topographic cartography and the ability to automatically send the IGC files to the XContest server for example. The potential of the Connect is no doubt huge but, in its current form, the instrument is a long way from realising its potential. ☹

[www.flytec.ch](http://www.flytec.ch).



The Micro-USB socket for charging and for some of the communication. Next to it is an audio socket, which can also be used by a speed sensor with a cable. The Flylink cordless sensor will also soon be available.



Airspace is already displayed and alarms on approaching it will be available in the next software version very soon.



**Technical data**  
**Size:** 142 x 88 x 23 mm  
**Weight:** 314 g  
**Screen:** Tactile LCD 240 x 320 points à 16 niveaux de gris, utilisable avec des gants.  
**Sensors:** GPS, barometer, accelerometer, gyrometer, magnetometer  
**Energy:** Accu Lipo  
**Autonomie:** 'about. 20 heures  
 Temps de charge: 5 heures  
**Interfaces:** WiFi, USB, Bluetooth Low Energy (activation logicielle en attente), FlyLink (Sensors Flytec).  
 Emplacement carte SD pour données cartographiques..  
**Price:** about. 700 €

# FLARM ANTI-COLLISION

Some top of the range variors from various manufacturers can, or could be, equipped with FLARM anti-collision modules. This is the case with the 6030, and will also soon be the case with the Connect.

FLARM is above all used by sailplanes, but more and more paraglider pilots are envisaging using it.

We'll explain how it works and the results of our tests in a future edition about collisions.. ✎



The FLARM module on the old 6030 isn't compatible with the Connect; the latter uses a different one.

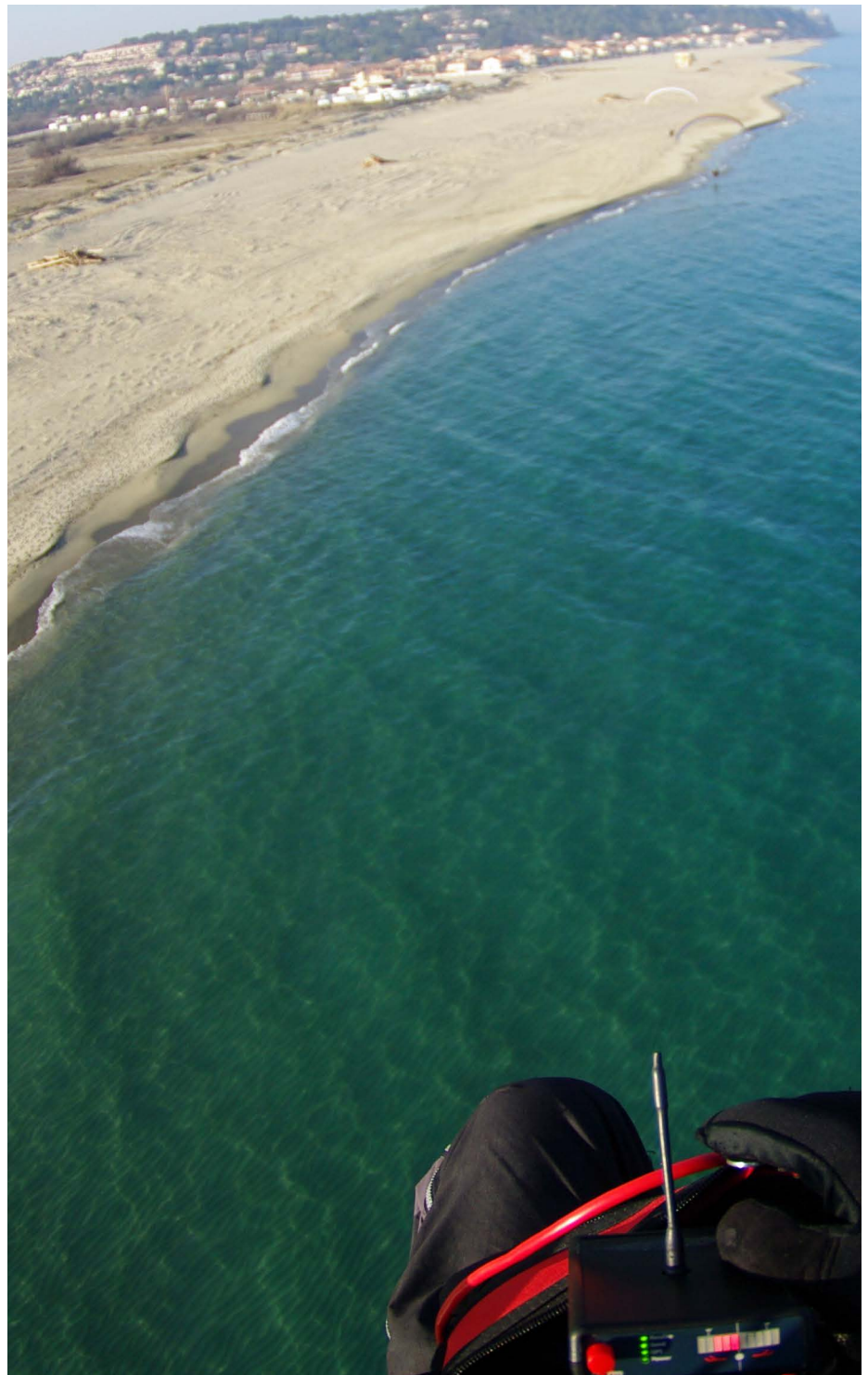

For voler.info, Mathieu Rouanet is equipped here with a FLARM box like the one used by lots of glider pilots. We approached head on, also on a paramotor and similarly equipped. The FLARM in the cockpit clearly alerted him of our approach...



# FLYTEC ELEMENT



The Flytec Element has reverted to the shape of the previous generation of entry level Bräuniger/Flytec instruments, but even in the elementary version, it has a GPS. Given the price of GPS chips today, it's a logical development. This instrument follows the Flytec tradition of having no nasty surprises. Its high contrast non touch sensitive screen, is made up of a fixed mask and a small graphic field, which shows all the essentials for a thermic flight and first XC's, including a tool for finding thermal cores. The instrument also offers navigation to waypoints and following of routes. There are also competition functions, and others, like one optimising the route, have been promised. The Element will need regular updates.



Nice buttons, being raised they are easy to find.





It's worth bearing in mind that the launch of a new Element, the 'Speed' has been announced, with less buttons, less functions, no flight recorder but specialising in speeds (speed/ground, speed/air with an optional external sensor, direction and speed of the wind). This instrument takes into account the needs of beginner leisure pilots.

A modern approach: we know that even, and especially, for them, knowledge of speed/ground and the wind speed are very important safety elements!  
Approximate price: 350 €.

**Technical data**  
**Size:** 138 x 74 x 23 mm  
**Weight:** 183 g  
**Ecran:** LCD noir et blanc masque fixe plus champ graphique  
**Energy:** 2 piles AA, Autonomy 30h  
**Sensors:** GPS, barometer  
**Interfaces:** USB et prise anémomètre  
**Price:** about. 470 €

**8.0**

**TIGER 160**

**FLY 200**

**MINI 3**



**X-RACE 8.0**  
X 8.0

**FUNFLYER**  
X-T X-RACE

**FUNFLYER 200**  
X-RACE 200

**FUNFLYER MAX**  
FUNFLYER BI

80 cm<sup>3</sup>  
17 PS  
11 kg  
115 / 130 cm  
50 / 55 kg

160 cm<sup>3</sup>  
24 PS  
14 kg  
115 / 130 cm  
63 / 70 kg

Hubraum  
Leistung  
Gewicht  
Propeller  
Schub

200 cm<sup>3</sup>  
27 PS  
16 kg  
130 cm  
80 kg

270 cm<sup>3</sup>  
33 PS  
20 kg  
160 cm  
110 kg

Engine	Propeller Size	50	60	70	80	90	100	110
8.0	115 cm	50	60					
	130 cm		60	70	80			
TIGER	115 cm			70	80	90		
	130 cm			70	80	90	100	
F200	130 cm			70	80	90	100	110

Wettkampf Sports Casual

Einsatzbereich der Motoren je nach Pilotengewicht und Propellergröße

Motorschirm-Antriebe von **ADVENTURE**

Im Fußstart-Chassis oder am Trike



During our test, it was on the verge of getting airspace but this function was then delayed by a few weeks. The instrument won't display airspace boundaries but will warn of their proximity with arrows and distance information.

There will, no doubt, be other new functions which could be installed thanks to the graphic part of the screen, whose pixels can be used to show anything the developers want.

Obviously, the Element records track logs in IGC format and their communication is done easily via a USB socket in 'external hard disc' mode.

In summary, it's a nice well made instrument, in a very strong case with a nicely contrasted screen and with all the essential functions and lots of potential for development. ☺

[www.flytec.ch](http://www.flytec.ch)



The Element in red; the barograph on the screen shows the last few minutes which is very practical.

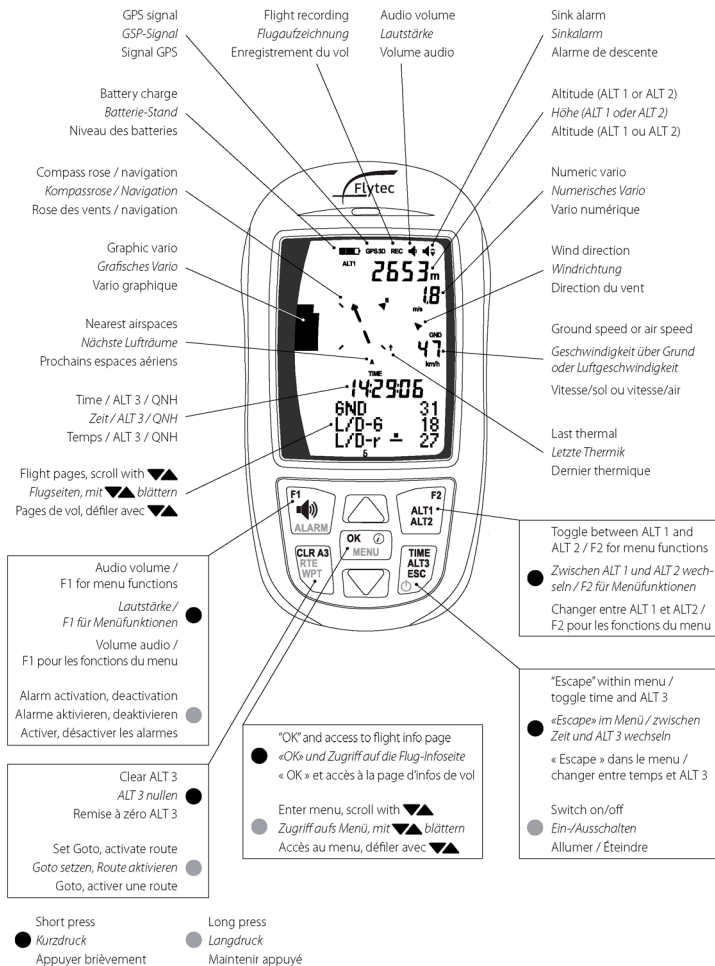

Airspace warnings will soon be given with arrows and symbols. Left, the airspace situation; right, the display on the instrument.

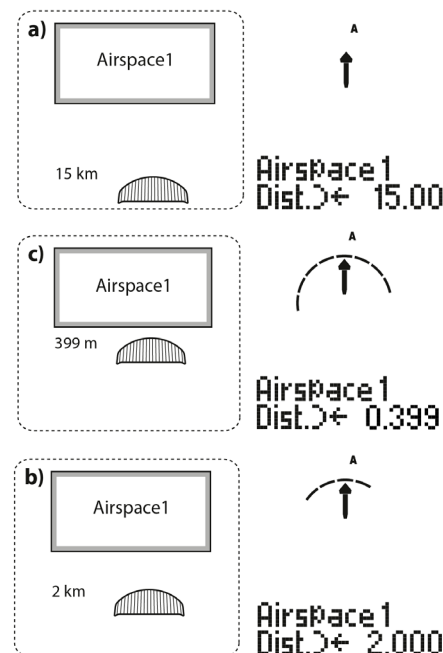

# TOPOGRAPHY, AIRSPACE, VILLAGES AND RIVERS



The steeper the landscape, like here, the more the grid needs to be finer to take into account the irregularities. In practice, the models record an elevation every 90 m horizontally.  
Photo : Markus Gründhammer/Skyman

## TOPOGRAPHY, AIRSPACE, VILLAGES AND RIVERS

As a reminder, here are a few explanations about the different cartography used in certain instruments. Topographic files exist which contain the altitudes of each point on a given grid for a given region. By uploading it onto a compatible instrument, the latter can at any given time know the elevation of the relief underneath the pilot, and therefore the pilot's height above the ground.

In addition, it allows a map to be drawn of the relief, by representing the different elevations by shades of colour (or levels of grey). But these are big files because they contain the 3D coordinates for a grid of 90 m x 90 m of the Earth's surface.

To get your bearings even more easily, some instruments can display, in addition, the names of villages and mountains as well as roads. This sort of information generally comes from Open Street Map.

Lastly, the vast majority of GPS instruments can display airspace, even if they don't have topographic maps. It's easy; the airspace is found in free databases and is defined by the geographic coordinates in that area, which don't take up much space in the memory.

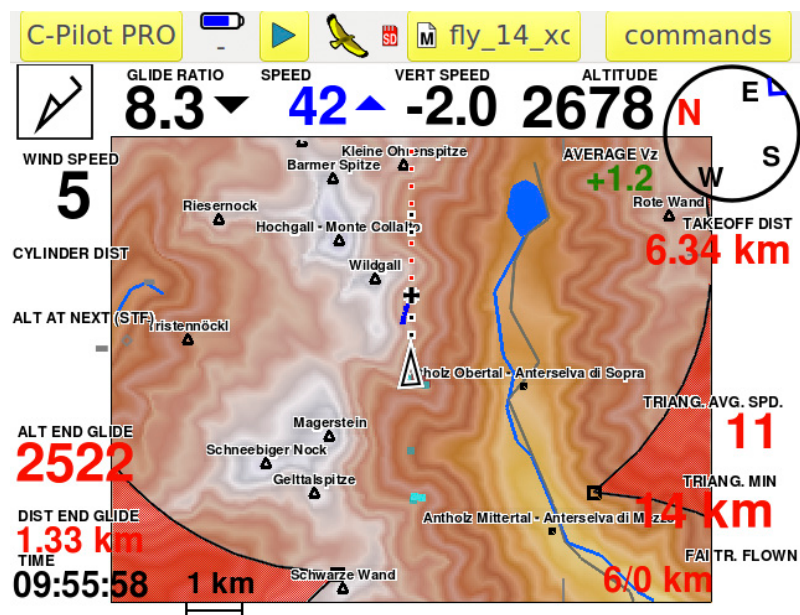

# COMPASS C-PILOT EVO



Compass became well known as a company just before 2010 when they brought out their top of the range C-Pilot Pro. With its touch sensitive colour screen, and freely configurable, it was undeniably one of the pioneers of flying with Hi-Tech. With a price to match of 1,200 €, it is also one of the most popular instruments used by top level competition pilots. One of the principal reasons is the ability to freely configure the display. In Edit mode, you can easily, directly on the screen, pull a dial or a value from one place to another, as well as enlarge or reduce them as you wish.

For example, competition pilot Ulrich Prinz has massively increased the graphic display of the compass showing the next way point; this allows him to see at a glance if he's got the cylinder or not. Ulrich is part of the group who've been hooked on the C-Pilot Pro/Evo right from the beginning and won't let go.



The first C-Pilot Pro that we tested in 2010. It was well ahead of its time and apart from its battery life, which could sometimes be a bit limited, we only found a few minor faults, mere details. In 2014, the updated version, the 'Evo', came out.

**Technical data**  
**Dimensions:** 15.4x13x2.8 cm,  
**Display:** Touchscreen, color 640x480 pixels, 5,7",  
**Weight:** 542g  
**Energy:** Accu Li-ion, 3.7 V 6800 mAh,  
**Autonomy:** 13h- 16h,  
**Sensors :** GPS, barometer  
**Interfaces:** USB, Bluetooth, serial port, SD Card,  
 GSM /GPRS-Data (option 90 €).  
**Price:** 900 €



The 5.7" colour screen, with its 640 x 480 pixels is relatively readable in daylight too. It's touch sensitive and reacts just a little bit slower than a modern smartphone screen. On the other hand, it works with gloves as well.

Two years ago a new version of the C-Pilot Pro came out. The price of the new C-Pilot Evo is about 900 euros, whilst being flatter and more robust, and it has gained an important function: as an option there is a slot for a GSM card chip allowing live tracking. Other advances: the battery life has increased to 15 hours (that's very good for a real computer), and its screen is more readable in full sun.

Recently the cartography has been further improved; you don't just see the airspace and the topography for the region you're flying over, but also the names of the towns and mountains, as well as the rivers and roads.

A strong team who have been together for a long time.  
 Left, Luca Basso.  
 Middle, Deivi Gavriil, who in particular looks after the technical aspects of the equipment.  
 Right, Cesare DePieri, the manager. Not in the picture, Vincenzo Piazza, professor of physics at Pisa University; he takes care of the software development.



A photo of production in Italy: The screen alone costs the company more than 200 €, according to Compass..



It's also possible to see if your current trajectory will go over a mountain or not. By default, the map turns as a function of the direction of the flight. Very clever management, which is fully customisable, changes the page set up on the screen and the level of zoom as a function of the flying situation. There are also functions to optimise a distance flight with a suggestion, as soon as it's possible, to complete an FAI triangle.

The menus on the system, based on a version of Linux, are very intuitive. One small problem: sometimes (albeit rarely) the system freezes briefly.

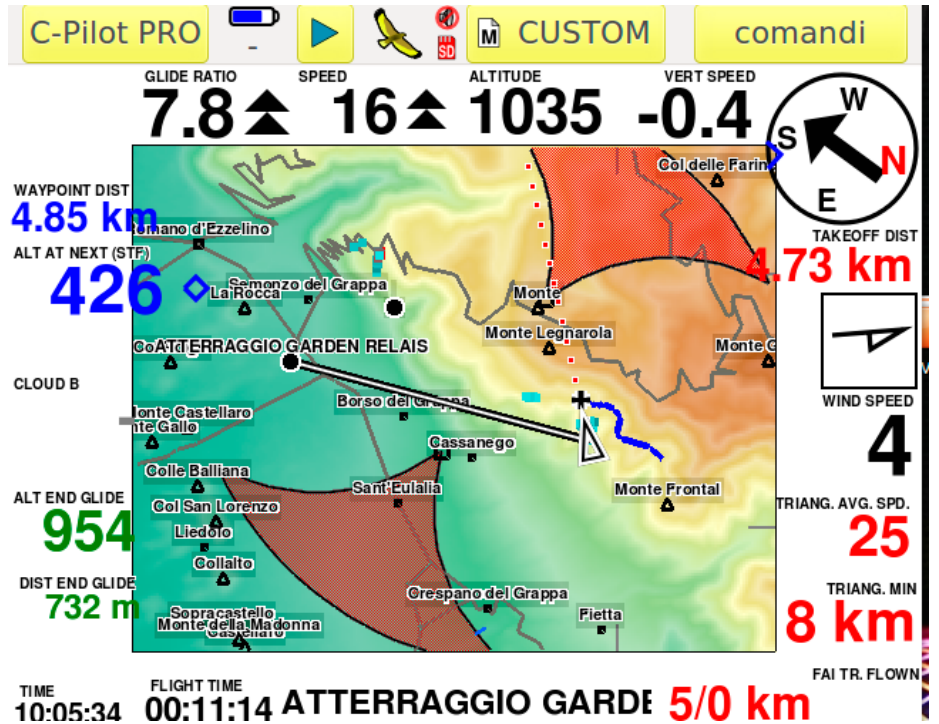

Above the slot for the SD card is the slot for the SIM card which is useful for live tracking.

The sectors in red show possible turn points to complete an FAI triangle. The topography has been improved by the addition of the names of the hills and villages.



In summary, it is without a doubt one of the most comprehensive instruments of our time, high performance and nice to use. The price, having decreased compared to the first version, seems to us really very reasonable given all the functions available.

The developers are on the constant look out for possibilities: the live tracking on LiveTrack 24, for example, will soon be two way, and the pilot will be able to see live on his screen the position of any other participants. Another function which is currently being refined by Compass is a vocal output system to read aloud important flight parameters.

Numerous values from the internal and external (C-Probe) sensors are recorded and can be sent for analysis.

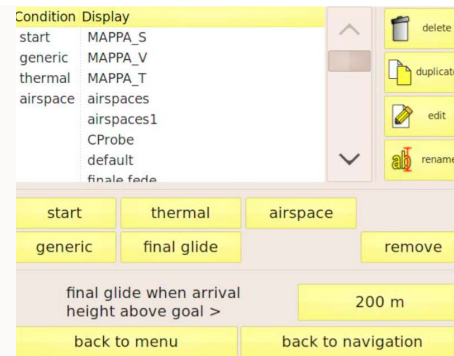
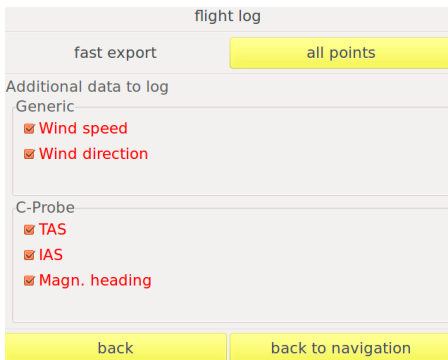

The user can set an almost unlimited number of different screens and the conditions as to how they will appear.

A tool for finding the core of thermals is also available.

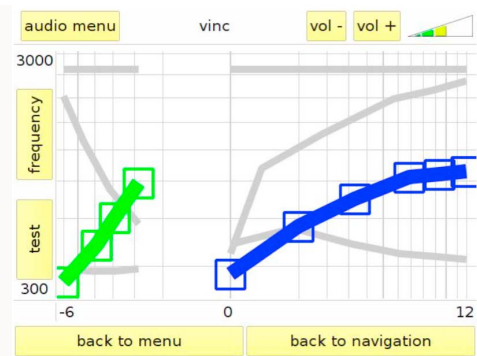
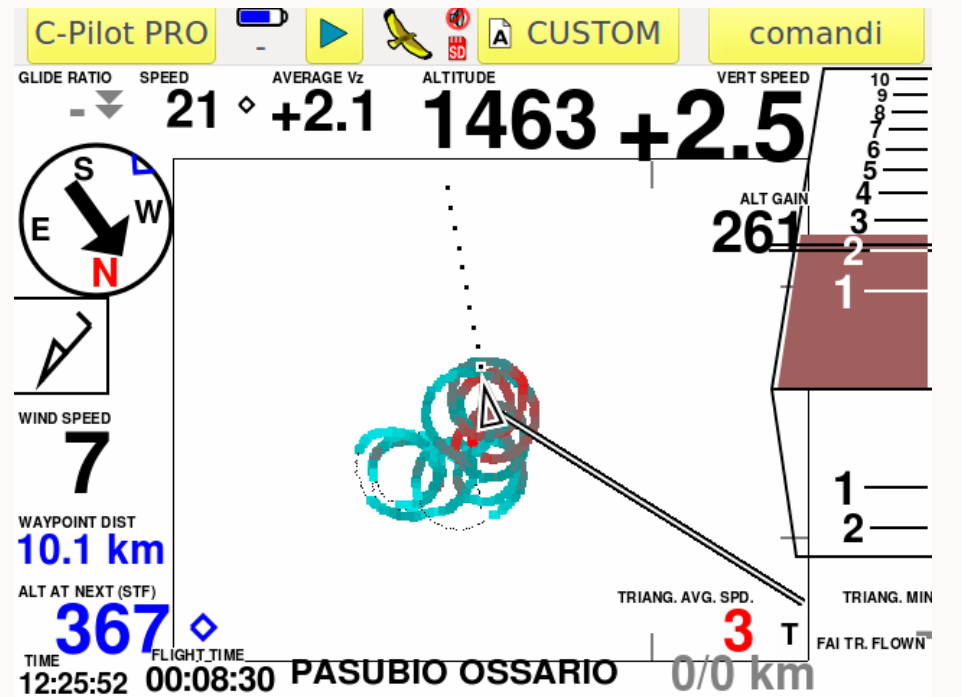

The acoustic profile of the vario can be directly modified on the touch sensitive screen.

A normal USB socket for charging and also for the connection to a computer.





# COMPASS EASY PILOT



**Technical data :**  
**Dimensions:** 83 x 155 x 32 mm **Weight:** 330 g -  
**Display:** Greyscale-Touchscreen 240 x 320 pixels , 3,7"  
**Sensors:** GPS, barometer- **Interfaces:** USB, Bluetooth (option), serial port, GSM/  
 GPRS-data (option 90 €) - **Price:** about. 600 €

**C**ompass have brought out smaller versions of their flagship instrument. The most basic version is called the EasyPilot but as far as the functions go, it is almost a C-Pilot.

The most notable difference is that the instrument is equipped with a greyscale touch screen with less resolution. Its quality is average for greyscale screens. The display format is therefore smaller, but almost all the functions on the C-Pilot are integrated, including those used in competitions as well as the optimisation for FAI triangles. On the other hand, the representation in greyscale isn't readable enough to display topography; this function has therefore been deactivated.

Even for this model, there is an optional SIM card slot (under the SD slot).







Photos: Compass

A very interesting product which has almost all the functions of the C-pilot Evo, but is less expensive.

The instrument is 30% cheaper than the C-Pilot, whilst benefiting from most of its functions on its touch screen. The Easy Pilot seems to us to be highly placed in the instrument market. ✂

[www.compass-italy.com](http://www.compass-italy.com)

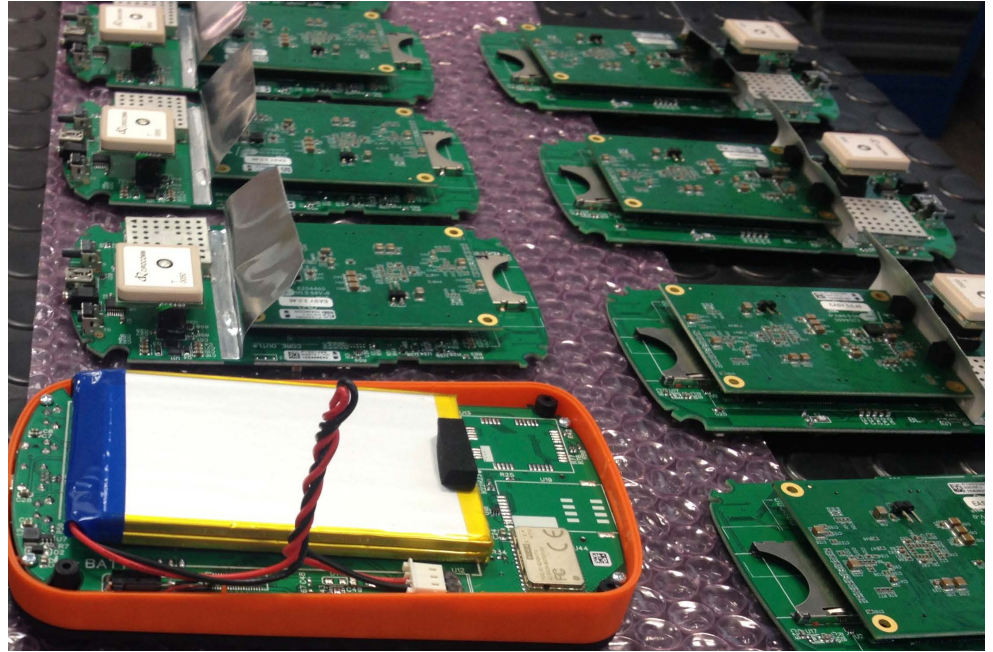

# KANGOOK PARAMOTORS

7 styles of cage  
6 attachment systems  
& the largest range of products  
for paramotoring

## FLY HIGH ABOVE COMPETITION

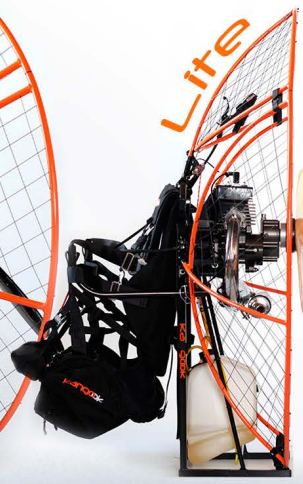

Komfort  
Tandem trike



[www.kangook.ca](http://www.kangook.ca)

# COMPASS XC-PILOT



For the moment the technical information hasn't been published because it is still subject to possible changes. When we tested it, pictured here next to the C-Pilot Evo, the instrument weighed 330 g. Dimensions: 83 x 155 x 32 mm

A screen with a very high resolution (640 x 480 pixels on 3.7") on this prototype instrument.

The XC-Pilot is, on a software level, almost identical to the C-Pilot. It has a colour touch screen, which allows you to display topographic maps like on the C-Pilot Evo, just a little smaller. And as a consequence it is lighter, 330 g instead of 540 g. This could therefore be an alternative for pilots who want to lighten their cockpits, whilst still taking advantage of all functions on the C-Pilot. The screen on the prototype instrument that we tested was amazing as far as resolution was concerned. It all worked the same as on the "big one", except that it is in portrait format and the writing is smaller because all the information is concentrated on a smaller surface. As far as the price is concerned, which will be announced shortly, this instrument could be just the ticket. ✈️





# SKYTRAXX 2.0 PLUS



**Technical data**  
**Size:** 120 x 98 x 25 mm - **Weight:** 176 g - **Display:** Grayscale  
**Energy:** Lithium-Ion 2 600 mAh  
**Autonomy:** 40 h **Sensors:** GPS, accelerometer, magneto  
**Interfaces:** USB, Bluetooth  
**Price:** 499 €

**T**he Skytraxx 2.0 PLUS is the successor to the excellent Skytraxx 2.0. The difference is that it has a Bluetooth connection, as well as a magnetometer for the electronic compass, and also an accelerometer. The Bluetooth connection has been added to allow a connection whilst flying, to a tablet for example. Some competitors use 7" tablets as high performance map readers. The first Skytraxx was Bluetooth compatible, whilst the 2.0 no longer was. However the Skytraxx 2.0 PLUS includes all the features which made the 2.0 a success.

It was one of the first varios to offer a large memory of 4 GB. Since then, the others have followed by adding slots for an SD card. It's essential, given the growing demand for cartography to be displayed.

Raised keys make them easy to find even with gloves.





The Skytraxx team: founder Michael Blank and Swiss importer Manfred Braun. Everything started twelve years ago with the first version, pictured here on the left.

The Skytraxx 2.0 PLUS also displays airspace and any paragliding take offs in the region. It also includes a topographic data base so it can display, at any time, the height above the ground. Skytraxx was one of the first manufacturers to offer this function. Since then, this has become standard, at least on most variors with enough memory or a slot for an SD card.

The airspace can be updated via the USB socket.

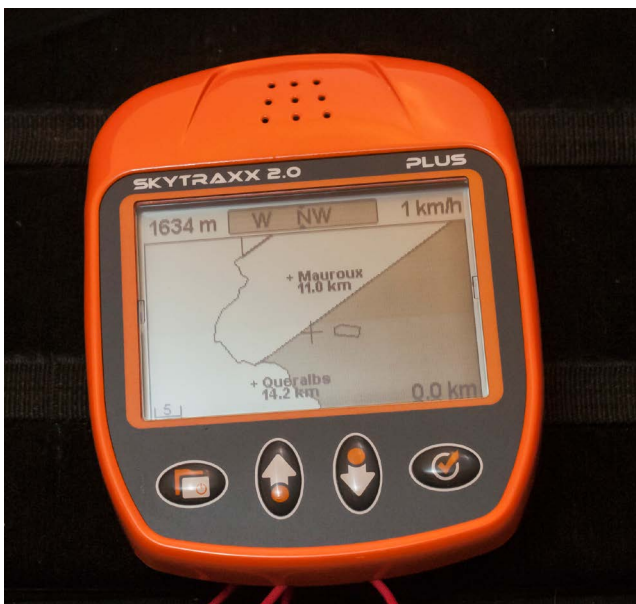
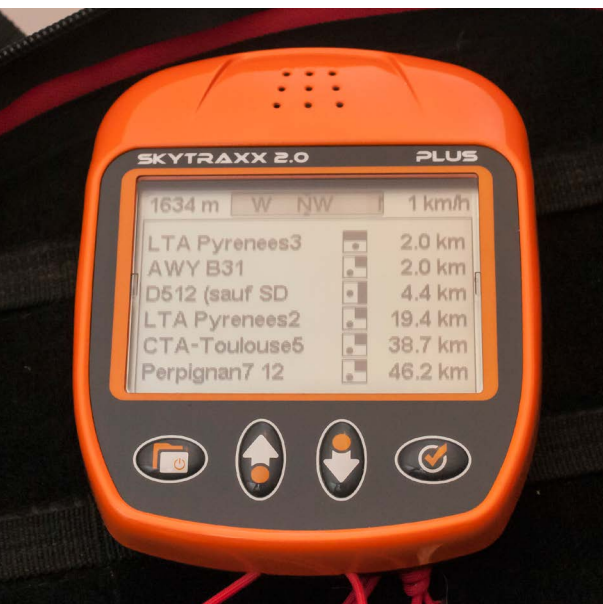

On the other hand, the Skytraxx doesn't use this information to display the topography in a graphic fashion. On a screen with 4 levels of greyscale, it wouldn't be very readable.

The 240 x 160 pixel screen has a lot of contrast in full sun. The Skytraxx 2.0 PLUS is also one of the instruments which is the most intuitive to use. The layout of the elements displayed is well thought out, and can't be modified, except for the value of the three fields. The intuitive use is also due to the layout and the logic of the four buttons.

The Skytraxx is also designed for XC pilots; over and above the normal navigational functions, there is even a function to optimise FAI triangles. In summary, it's a very comprehensive instrument which shines especially due to its capacity to put the emphasis on the essential, whilst offering more for those who want to go further. You can even activate a 'voice' function which will alert you when you enter airspace. ✈

<https://www.skytraxx.eu/index.php?route=common/home>



The screen is very readable and the layout of the information is well thought out. Of course the instrument displays the speed and the direction of the wind too.

## G FORCE ALERT !

The Skytraxx offers an accelerometer, which amongst other things, alerts the pilot when a certain threshold has been passed. We've been trying to encourage instrument manufacturers to include this type of safety feature for a long time now. Following the work of Paul Pujol, it clearly appears that certain accidents are due to moments of temporary unconsciousness; sometimes the pilot suffers this just after being subjected to substantial G forces. As a general rule, the pilots don't even remember that they passed out. An adjustable alarm which goes off before reaching this threshold would therefore be very useful.

# SKYTRAXX 3.0

The manufacturer Skytraxx has added a new instrument into their range. It will be on sale from May 2016 onwards, and we haven't managed to test it yet. The Skytraxx 3.0 is bigger than the Skytraxx 2, which will remain in production. The version 3 has a 4.3 inch, very bright, colour screen. It isn't touch sensitive because the manufacturer wants to keep the maximum amount of contrast. This is difficult to achieve with screens which have a touch sensitive layer.

The instrument works under Linux and the source will be open. The developers will therefore be able to adapt it easily. The instrument has a USB socket which can work in host mode. It allows a keyboard, a WiFi stick, a Bluetooth stick or a hard disc to be plugged in. The price is about 750 €. [✈](#)



# ASI



**A**SI Flight Instruments was the first manufacturer to offer a vario, the FlyNet, which included a Bluetooth connection which wasn't just compatible with Android telephones, but also with iPhones. It's worth bearing in mind that because of political restrictions by Apple, the normal Bluetooth links didn't have the right to communicate serial data other than audio wave forms (head phones). It was only on condition that the chip used would be certified by Apple, on investing considerable sums of money. ASI did it and thus opened up the possibility for excellent applications like Skylogger to display a very precise vario.

With the advent of Bluetooth 4 LE it is no longer a problem; iPhones from 4S upwards are accessible to Bluetooth connections of this type without certification.

The FlyNet XC1 is the follow up to the FlyNet. It isn't just a vario, but also a GPS and a flight recorder. It serves as a stand-alone acoustic vario, or otherwise as a source for GPS data as well as information from its accelerometer which it transmits to a smartphone or a tablet via Bluetooth 4.0 low energy or standard Bluetooth 4.0. The dual language is sufficiently rare that it deserves a mention. The Sensbox by Flytec, for example, doesn't talk to old smartphones and iPhones below the 4S, because only Bluetooth LE is installed.

By plugging in the Flynet XC1 via USB to a computer, the vario behaves like a hard disk, and you can extract flights very easily. The FlyNet XC has an internal memory of 256MB (about 1800 hours of flight with a point every second).

There is also a TXT file containing configuration parameters, which you can adapt according to your needs. You can define four levels of sound, or indeed cut the sound when an application is connected via Bluetooth that can make its own 'beep'. It would be good if we could program more parameters, such as for example, the sensitivity of the acoustic vario or the frequencies, but the standard adjustment works no doubt for most pilots.

FlyNet have, for a long time, had their own application but, like lots of manufacturers, have adapted excellent applications like Skylogger and Air Nav Pro so that they can make use of data from this precise GPS-vario-accelerometer. Support for the ASI application is no longer maintained.

With a price tag of 342 €, the FlyNet XC1 certainly isn't cheap, but it is very compatible, equally with the old smartphones and goes very nicely in tandem with some professional applications.

[http://www.flynet-vario.com/admin/compatible\\_apps/index](http://www.flynet-vario.com/admin/compatible_apps/index)



**Technical data**  
**Sensors:** GPS, barometer  
**Interfaces:** USB, Bluetooth 4.0 low energy, Bluetooth 4.0 standard  
**Size:** 65 x 65 x 20 mm  
**Weight:** 51 gr  
**Autonomy:** 15 h

**Price:** 342 €







# SYRIDE SYS'NAV V3



**S**yride was the first manufacturer to design instruments to be attached onto the riser. The idea is great: there is no better place to be able to see an instrument. Obviously this only works if the vario is sufficiently small and light. And in this too, Syride is a pioneer. When it came out, the first version was already the smallest and lightest instrument.

Normally it is counted as one of the 'minis' for hike and fly, except that the SysNav v3 in particular, really has everything a 'grown up' one has. Thanks to its integrated SD card, it contains all worldwide airspace and topography. Previously, on the SysNav v1, the topographic data had to be loaded every time you changed country or even region because there wasn't enough space.



Photo Sascha Burkhardt

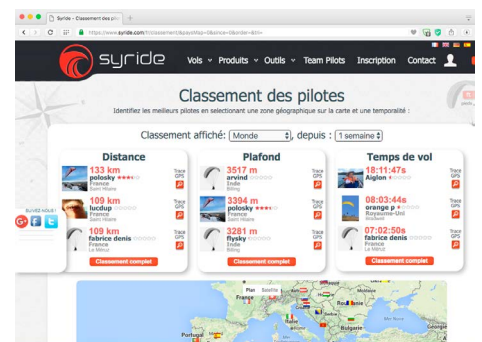

Syrider started more than five years ago with this innovative instrument as well as the online collaborative server.



Photo Martin Müller

This attachment is very practical, but only possible with a light instrument. Before taking off, you just need to pay a bit more attention not to knock the instrument against the harness. Once you're in the air it isn't a problem.



Photo Veronique Burkhardt

Now with the SysNav v3 everything is included and displayed on the greyscale screen. One thing which is unusual for this type of screen is that it's backlit which further increases its readability in certain conditions. The SysNav v3 also has an accelerometer and can thus display the G forces exerted on the pilot and also alert him when a certain level is passed. The accelerometer is also used in the new instant vario function, which as a consequence reacts a lot faster. On the other hand without the magnetometer and the gyrometer, the algorithm can't be as elaborate as the one on the XC-Tracer.

From their first instrument onwards, Syride very closely integrated the instrument's communication with the manufacturer's site. On the one hand, Syride has its own server for on line ranking; the flights are automatically transferred when the pilot connects his instrument to a computer. On the other hand, the screen layout of the instrument can be set up on the manufacturer's site, which sends out the configuration file afterwards.

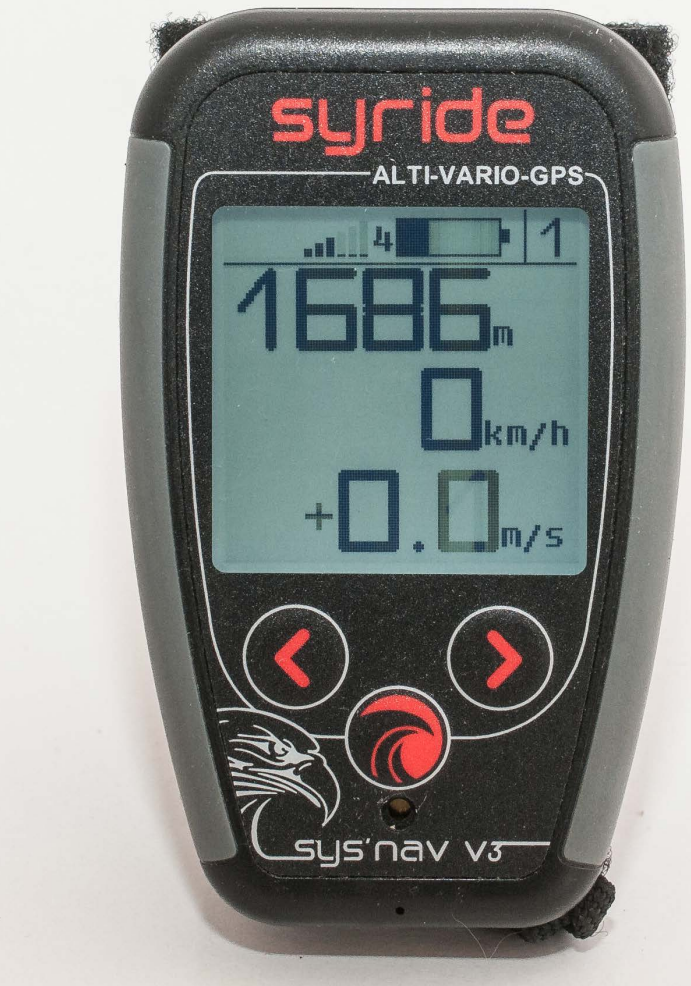

**Technical data**  
**Size:** 10 cm x 6,1 cm x 1,7 cm  
**Weight:** 91 g  
**Display:** Grayscale (Backlight)  
**Sensors:** GPS, barometer, accelerometer  
**Energy:** Accu Lithium Ion  
**Autonomy:** 45 heures  
**Interfaces:** USB  
**Price:** about. 399 €

The raised buttons, combined with a well thought out menu allow it to be used intuitively.



The layout of the elements on the screen can be set up on line.

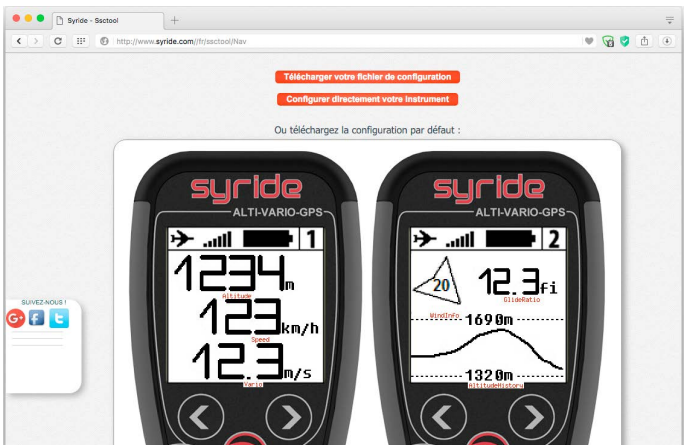

The original configuration has already been well thought out and it has the essential items over several pages. On the map page there is airspace, the track log of the flight and a graphic representing the topography.

It is also possible to use its navigation functions. There is a new function which shows if the current glide ratio is sufficient to pass over the relief or not.

All this is offered in an instrument which isn't just small, but also very economical: 45 hours (without back lighting).

Summary: Not a very expensive instrument given its functions. And above all, an instrument with a lot of performance given its size. ✈️

[www.syride.com](http://www.syride.com)



The graphic representation of the topography has been possible for several years, but the cartography used to have to be loaded region by region. It wasn't possible to keep the data for a whole country in the memory. Since the version V3 came out, there are no more problems; the whole world fits in! In the photo, one of the founders of Syride, Anthony Créteur.

The Syride team is based at St Hilaire. Here Marion Roche, who is responsible for international trade, with co founder Anthony Créteur.



# FLYMASTER LIVE SD



The Portuguese company created a sensation by offering, with the B1 NAV, the first instrument with integrated GPS for less than 500 €. Two years later, Flymaster brought out the 'Live', a top of the range instrument equipped with a slot for a SIM card so that it can be used as a live tracker directly on a server. Tracking is one of Flymasters specialities, because the company have always supplied the instruments for the X-Alps. Flymaster is also known for the reactivity of its developers. The range's instruments are all the same relatively classic size with a very big screen of 76 x 57 mm and 320 x 240 pixels. With a weight of 237 g, they are about average.

The greyscale screen is very readable, the display totally configurable. For this you have to download Designer, software which is compatible with Mac, Linux and Windows.

The beginning of Flymaster, seven years ago: the F1 tracker also used for the X-Alps and the B1, their first instrument, which was both powerful and cheap.





You can then freely position all the elements (dials, digital displays and maps). Just out, an on line service "Flymaster Cloud": the Designer software sends the instrument's flights to the Flymaster server (private or public depending on the pilot's choice). There the pilot can analyse point by point most of the values, including G forces encountered and the air speed if the sensor was connected. The Flymaster is very intuitive to use; the four buttons correspond to down arrow, up

arrow, escape and enter. We found it very easy to use. Lots of interesting calculations were possible and could be displayed on the screen. The representation of the topography in greyscale, with the names of villages makes it very easy to see where you are during an XC. It is also possible to display the height above the ground. All the functions which are useful for navigating are present, including optimisation of an FAI triangle.

All the Flymaster instruments can be connected to an M1 box, which wirelessly transmits CHT (Cylinder Head Temperature) and other important engine parameters. The Live SD is therefore also very suited to paramotoring. <https://www.flymaster.net/products/m1>

Some of the Flymaster team at St Hilaire.

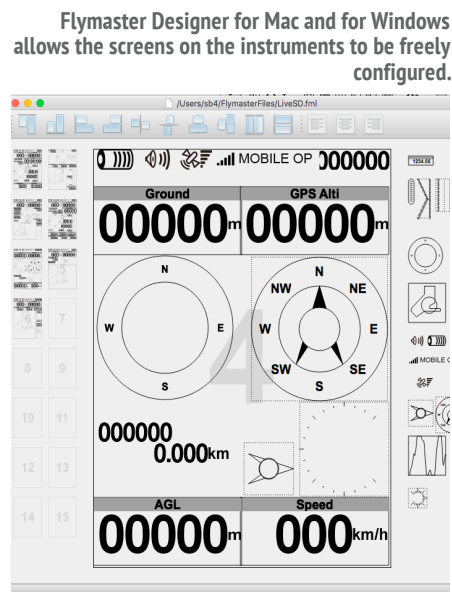
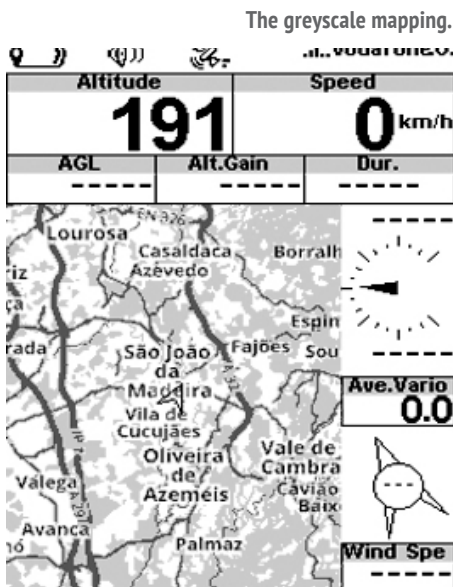



**Technical data**  
**Size:** 155x92x24 mm  
**Weight:** 237g  
**Screen:** niveaux de gris  
**Energy:** Accu Lithium-Ion 4000 mAh  
**Autonomy:** >30 h  
**Sensors:** GPS, barometer, accelerometer, magnetometer  
**Interfaces:** GSM/GPRS, USB, RF, Carte SD,  
**Price:** about. 700€

To be able to properly centre weak thermals, Flymaster offer a 'buzzer' function, which warns the pilot with a specific sound of the peripheral zones of thermals, where the sink rate is slightly better. Flymaster have also included an 'Instant vario' function which integrates the accelerometer into the calculations. On the other hand, as there isn't a gyrometer, it isn't a real AHRS system but Flymaster estimate that the use of such a function remains low.

In the 'Live' part, there is lots new. Now it is, for example, possible to record the whole flight directly from the instrument onto the XContest server. It will also soon be possible to send messages onto other pilot's instruments (but only from a computer, not from another instrument). In summary, the top of the range Live SD from Flymaster is a nice instrument to use and very comprehensive given its price.

It's worth noting that the manufacturer has just brought out an SD+ version of the most basic GPS instrument in this range. This instrument also has a slot for a SIM card and can participate in live tracking in the same way. It only costs 565 € and is only missing a few of the advanced functions useful in competitions. 🐘

[www.flymaster.net](http://www.flymaster.net)

The slot for the SD card has allowed the memory to be increased so that world wide mapping could be integrated.



Flymaster is the only manufacturer to offer a heart rate belt for these instruments. If the pilot wants, it transmits, via the Live SD, his heart beat onto the live tracking server. This belt isn't necessary any more to visualise G forces; in the SD version, there is the same sensor in the instrument too.



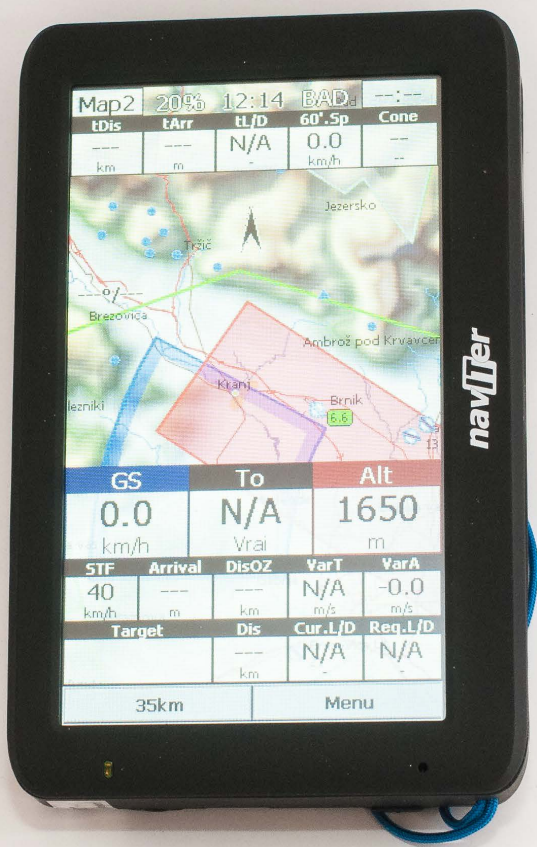

# NAVITER OUDIE 3+ COMING SOON THE OUDIE 4



**Technical data Oudie 3**  
**Size:** 135 x 86 x 25 mm  
**Weight:** 366 g  
**Screen:** 5" TFT Touchscreen.  
**Energy:** 9 600 mAh  
**Autonomy:** >12h  
**Interfaces:** Bluetooth, USB, Serial port, Jack 3,5 mm, SD-Card  
**Price:** 739 €

**M**ore than twelve years ago, we tested for the first time the cartographic/aerial navigation software, "SeeYou", for Pocket-PCs (the ancestor of Windows Mobile). For four years the author of SeeYou has sold an instrument with a touch screen with SeeYou already installed called the Oudie. It is now in its third version; the fourth, not yet tested, will soon be available. The case and the excellent screen (3+ onwards) will remain identical.

Just like the Windows Mobile software, the Oudie displays amongst other things a topographical map as well as airspace. You unwrap it, turn it on and it works. Everything is pre-installed, like the maps and the airspace. What's surprising is that it has a reputation of being very stable, despite using Windows.





The ergonomics is very good; you can click on information on the screen, like airspace, and extra information is displayed. The dials containing the values around the map can be easily modified by clicking on them. This instrument has rapidly become the favourite of some of the competition and XC pilots. It's true that it's the most comprehensive instrument, just below the Compass C-Pilot.

To download flights, the USB socket is required. The instrument also has a Bluetooth connection to communicate with a mobile phone (only Android) to allow live tracking for example.

The Oudie 3+ doesn't have extra sensors such as a gyrometer. But Naviter have found that a properly done AHRS algorithm can really improve the vario and will equip the Oudie 4 with these sensors and an instant vario function.

The owners of an Oudie 3/3+ can upgrade their instrument according to a specific scale, by sending them to the manufacturer. The upgrade is even free for those who bought it after the first of October 2015. ☺

[www.naviter.com/](http://www.naviter.com/)

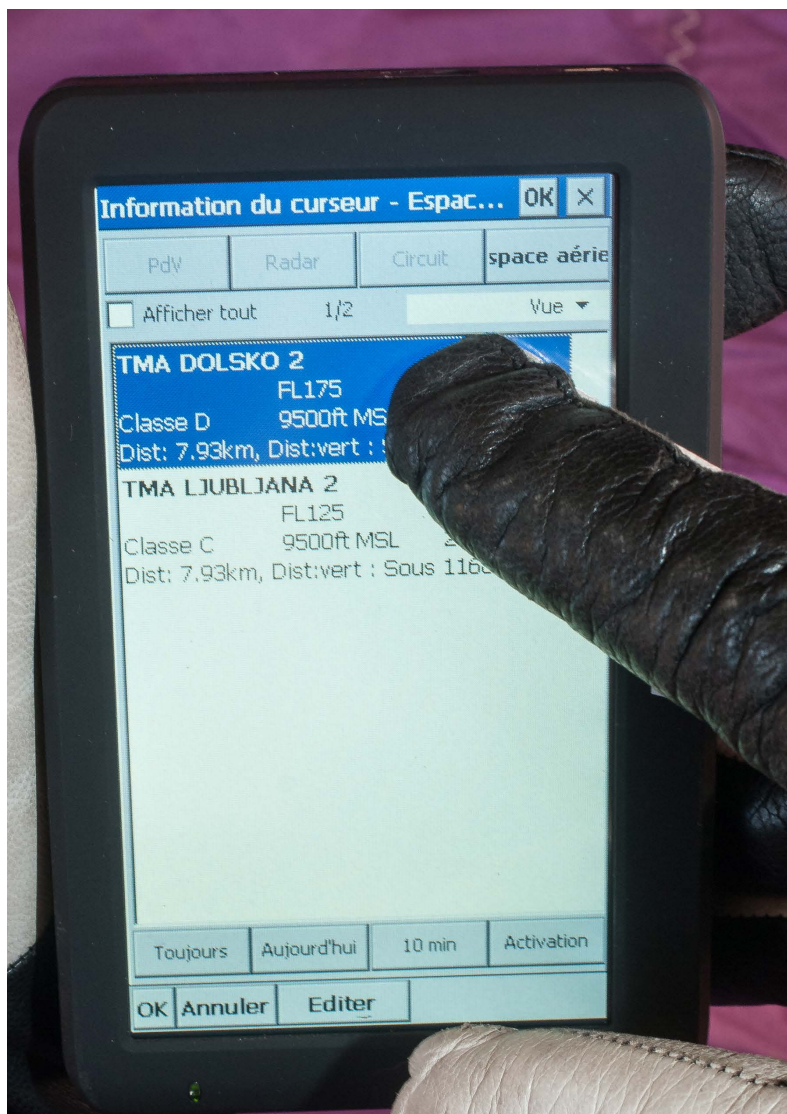

The touch screen is easy to use, even with gloves and very easy to read even in full sunshine. By clicking on an element on the map, the information appears. It behaves very like the tablets and smartphones we're used to.

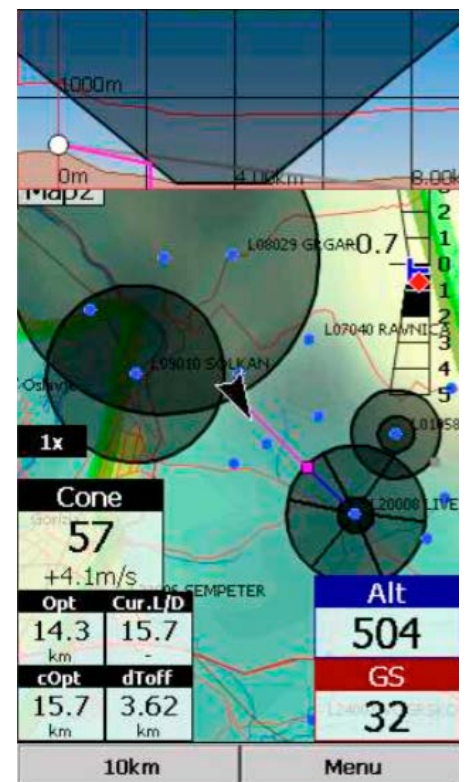



# ASCENT H1: THE SEQUEL

**Technical data**  
**Size:** 8,34 x 5,5 x 1,49 cm  
**Weight:** 93 gr  
**Sensors:** GPS, barometer  
**Energy:** Lithium-Ion 830 mAh  
**Autonomy:** 10h  
**Price:** about 300 €  
[www.ascentvario.com](http://www.ascentvario.com)

**A**scent is, with Syride, the first manufacturer to have offered a very small instrument which you can easily attach to the riser (or even to your arm like a watch, an Ascent innovation). Using it with the four buttons is very intuitive. The manufacturers learnt how to do it from the big mobile phone manufacturers.

Its functions are limited to the essential, but there too, after a pause, development took off and, in no time at all, airspace maps were available. It's the first time that this highly contrasted screen will display things other than letters and numbers. The instruments register IGC track logs for up to 50 hours at a rate of 1 point per second. They need to be extracted by USB. 📡





# DIGIFLY

Unfortunately the Italian Digifly instruments are missing from our tests. Yet they are a very old manufacturer with highly developed products. We'll look at them another time which will be very interesting because this manufacturer is said to offer an ARHS system based on three gyrometers, three magnetometers and three accelerometers each with three axes, so each axes three times on three types of sensors. We're looking forward to seeing that! 🇮🇹

[www.digifly.com/](http://www.digifly.com/)

# GPSBIP

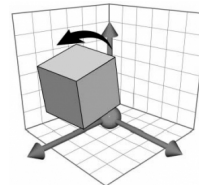

We're also looking forward to testing the GPS Bip, a solar powered mini vario-GPS with a voice output and IGC flight recorder, connectable via a cable to a Kobo type tablet. It will also offer a vario enhanced by integrating an accelerometer and a gyrometer. Due out soon. 🇮🇹

[www.lebipbip.com/](http://www.lebipbip.com/)

# SKYDROP



**T**he young manufacturer SkyBean sells its famous acoustic SkyBean vario (see photo further on in this edition), but they also have an ultralight GPS-vario, the Skydrop. The instrument only weighs 65 g and therefore lends itself perfectly to hike and fly usage. It is designed to be attached to a riser. The screen is really miniscule but it is back lit as soon as you press one of the three (non prominent) buttons. Its use has been well thought out. With a long click on the button in the middle you get into the menu which gives lots of options. Its amazing. There are several altimeters certain of which can be set by entering the QNH. It feels like being in a real aeroplane.

Another example: there is an auto start function on the track log recorder, so that as long as the pilot hasn't taken off, the vario doesn't beep at take-off. Thank you. It's a function which is becoming

more and more widespread, but you don't expect to see such finesse when you look at this mini instrument which is very mini at first glance. The beeps, once in the air are loud enough given that the instrument is attached to the riser. The reactivity is good. A buzzer function allows it to warn you of weak rising air on the edge of thermals. The Skydrop displays the ground speed in the air; calculation of the wind speed is expected soon. It is even possible to personalise the screens to a certain extent.

Another astonishing detail: this instrument also has Bluetooth, so it can communicate with an XCSoar type smartphone application. We're going to review this function, along with the new things which will have inevitably been added, in a future edition.

The price of 199 € seems right for this unique instrument. ✂  
[www.skybean.eu](http://www.skybean.eu)

**Technical data**  
Size: 62 x 98 x 22 mm  
Weight: 65 g  
Energy: Li-Ion (USB rechargeable)  
Autonomy: 7.5h  
Price: 199 €

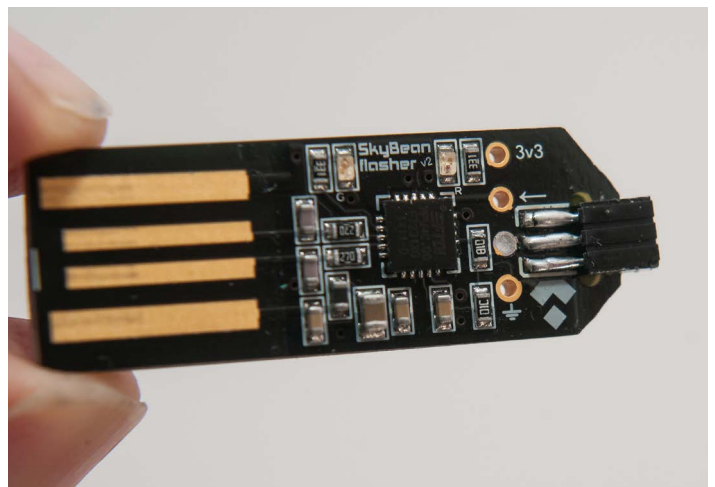



Photo: Sascha Burkhardt

**Technical data**  
**Size:** 28x62x15 mm  
**Weight:** 24 gr  
**Energy:** button battery - **Autonomy:** 250 h  
**Price:** 89 €

In a future edition we'll review in detail all the mini varios that are great for hike and fly, such as this Skybean with a choice of wood or plastic and which can be updated via USB. It's a great instrument, is very light, works well and is designed by the Slovakian team who also made the Skydrop. [www.skybean.eu](http://www.skybean.eu)



# MOTOR MONITOR



**M**ost of the instruments reviewed on the previous pages can be used on paramotors too. Some manufacturers like Flymaster offer extra boxes allowing motor parameters to be displayed on the navigation instrument. Others like Flytec offer this type of instrument, but aren't sure whether or not they are going to persevere with the motorised market.

We'll take a look at the existing systems in a future edition. We're currently testing the MotoMonitor from the Polish company Fly Electronics. Their box has an excellent screen and is the equivalent of a vario/motormeter on its own. It displays, in addition to the altivario and navigation functions, RPM, EGT and CHT as well, if you add all the sensors. Price only 399 €, including the sensors. More information coming very soon. .✈

<http://www.flyelectronics.eu/>



Concept, editor in chief, webmaster: Sascha Burkhardt  
test pilots: Sylvain Dupuis, Pascal Kreyder, Cédric Nieddu  
Layout: Véronique Burkhardt  
Translations: Ruth Jessop  
iOS development: Hartwig Wiesmann, [Skywind](#)  
Android development: Stéphane Nicole [www.ppgps.info](http://www.ppgps.info)  
Logo designed by Indalo: All rights reserved by Michael Sucker [indalo@web.de](mailto:indalo@web.de)  
Magazine free.aero  
SIRET 807821319 00017

Editor and director of the publication:  
Sascha Burkhardt, [contact@free.aero](mailto:contact@free.aero)  
F-66210 Saint Pierre dels Forcats  
Tel. +33 6 70 15 11 16

The contents of free.aero (photographs, articles, videos etc) are protected by copyright.

Anyone has the right to duplicate, redistribute or publish our online magazines, as long as they don't modify them. It is strictly forbidden to copy articles or photographs, to publish them, to use them in any other format or context, or to use them in another piece of work.

# free.aero

WORLDWIDE PARAGLIDING AND PARAMOTORING MAGAZINE. FOR FREE.



**ALL ABOUT FLYING.  
ANY TIME.  
ANY PLACE.  
ALL FOR FREE.**

THE WORLDWIDE **ALL** DIGITAL  
PARAGLIDING AND PARAMOTORING MAGAZINE.